



**PDHonline Course C540 (11 PDH)**

---

# **Geotechnical Engineering Series - Deep Foundations**

*Instructor: Yun Zhou, Ph.D., PE*

**2020**

**PDH Online | PDH Center**

5272 Meadow Estates Drive  
Fairfax, VA 22030-6658  
Phone: 703-988-0088  
[www.PDHonline.com](http://www.PDHonline.com)

An Approved Continuing Education Provider



U.S. Department of Transportation  
Federal Highway Administration

Publication No. FHWA NHI-06-089  
December 2006

**NHI Course No. 132012**

---

# **SOILS AND FOUNDATIONS**

**Reference Manual – Volume II**

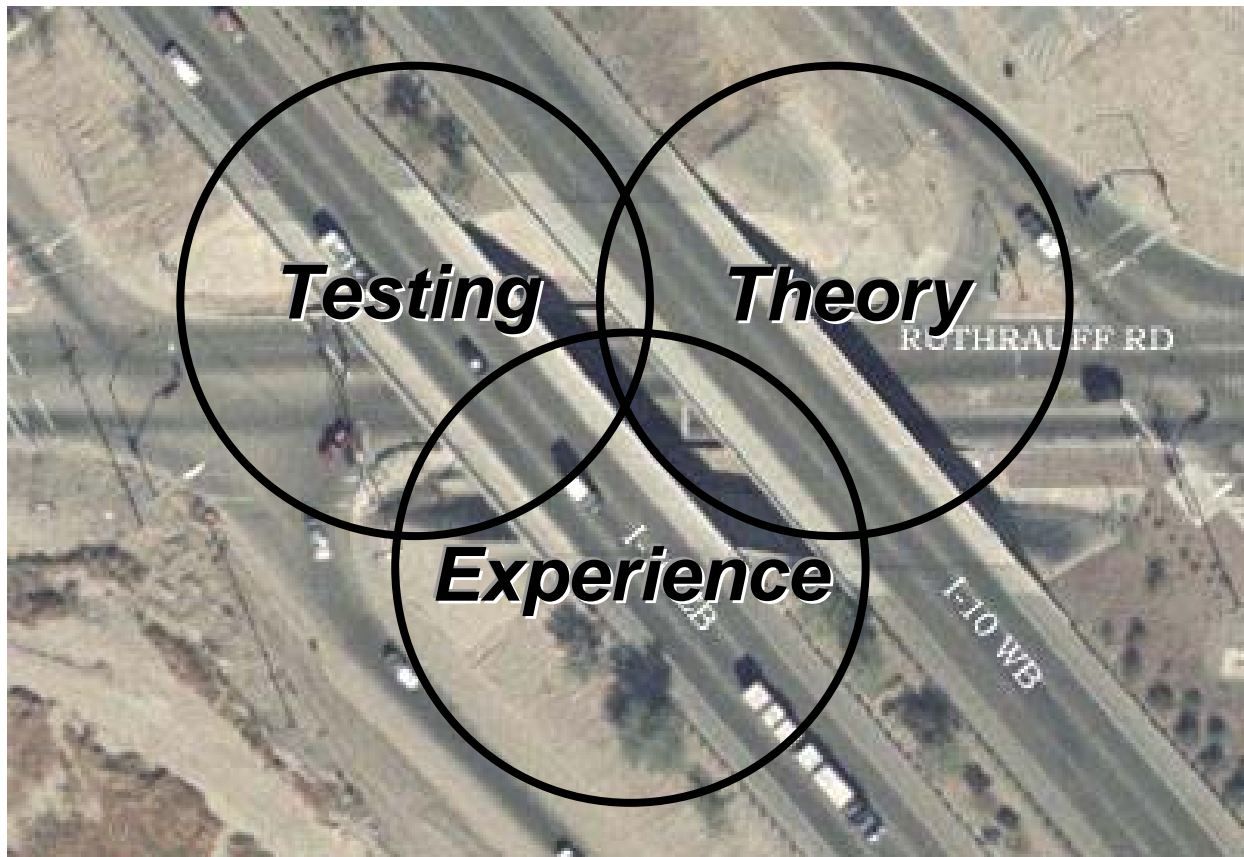

*National Highway Institute*

**Technical Report Documentation Page**

1. Report No. FHWA-NHI-06-089	2. Government Accession No.	3. Recipient's Catalog No.	
4. Title and Subtitle  SOILS AND FOUNDATIONS REFERENCE MANUAL – Volume II		5. Report Date December 2006	
		6. Performing Organization Code	
7. Author(s) Naresh C. Samtani*, PE, PhD and Edward A. Nowatzki*, PE, PhD		8. Performing Organization Report No.	
9. Performing Organization Name and Address Ryan R. Berg and Associates, Inc. 2190 Leyland Alcove, Woodbury, MN 55125 * NCS GeoResources, LLC 640 W Paseo Rio Grande, Tucson, AZ 85737		10. Work Unit No. (TRAIS)	
		11. Contract or Grant No. DTFH-61-02-T-63016	
12. Sponsoring Agency Name and Address National Highway Institute U.S. Department of Transportation Federal Highway Administration, Washington, D.C. 20590		13. Type of Report and Period Covered	
		14. Sponsoring Agency Code	
15. Supplementary Notes FHWA COTR – Larry Jones FHWA Technical Review – Jerry A. DiMaggio, PE; Silas Nichols, PE; Richard Cheney, PE; Benjamin Rivers, PE; Justin Henwood, PE. Contractor Technical Review – Ryan R. Berg, PE; Robert C. Bachus, PhD, PE; Barry R. Christopher, PhD, PE <i>This manual is an update of the 3<sup>rd</sup> Edition prepared by Parsons Brinckerhoff Quade &amp; Douglas, Inc, in 2000. Author: Richard Cheney, PE. The authors of the 1<sup>st</sup> and 2<sup>nd</sup> editions prepared by the FHWA in 1982 and 1993, respectively, were Richard Cheney, PE and Ronald Chassie, PE.</i>			
16. Abstract  The Reference Manual for Soils and Foundations course is intended for design and construction professionals involved with the selection, design and construction of geotechnical features for surface transportation facilities. The manual is geared towards practitioners who routinely deal with soils and foundations issues but who may have little theoretical background in soil mechanics or foundation engineering. The manual's content follows a project-oriented approach where the geotechnical aspects of a project are traced from preparation of the boring request through design computation of settlement, allowable footing pressure, etc., to the construction of approach embankments and foundations. Appendix A includes an example bridge project where such an approach is demonstrated. Recommendations are presented on how to layout borings efficiently, how to minimize approach embankment settlement, how to design the most cost-effective pier and abutment foundations, and how to transmit design information properly through plans, specifications, and/or contact with the project engineer so that the project can be constructed efficiently.  The objective of this manual is to present recommended methods for the safe, cost-effective design and construction of geotechnical features. Coordination between geotechnical specialists and project team members at all phases of a project is stressed. Readers are encouraged to develop an appreciation of geotechnical activities in all project phases that influence or are influenced by their work.			
17. Key Words		18. Distribution Statement	
Subsurface exploration, testing, slope stability, embankments, cut slopes, shallow foundations, driven piles, drilled shafts, earth retaining structures, construction.		No restrictions.	
19. Security Classif. (of this report)	20. Security Classif. (of this page)	21. No. of Pages	22. Price
UNCLASSIFIED	UNCLASSIFIED	594	

## CHAPTER 9.0 DEEP FOUNDATIONS

Foundation design and construction involves assessment of factors related to engineering and economics. As discussed in Chapter 8, the selection of the most feasible foundation system requires consideration of both shallow and deep foundation types in relation to the characteristics and constraints of the project and site conditions. Situations commonly exist where shallow foundations are inappropriate for support of structural elements. These situations may be related either to the presence of unsuitable soil layers in the subsurface profile, adverse hydraulic conditions, or intolerable movements of the structure. Deep foundations are designed to transfer load through unsuitable subsurface layers to suitable bearing strata. Typical situations that require the use of deep foundations are shown in Figure 9-1 and briefly discussed below.

- Figure 9-1(a) shows the most common case in which the upper soil strata are too compressible or too weak to support heavy vertical loads. In this case, deep foundations transfer loads to a deeper dense stratum and act as toe bearing foundations. In the absence of a dense stratum within a reasonable depth, the loads must be gradually transferred, mainly through soil resistance along shaft, Figure 9-1(b). An important point to remember is that deep foundations transfer load through unsuitable layers to suitable layers. **The foundation designer must define at what depth suitable soil layers begin in the soil profile.**
- Deep foundations are frequently needed because of the relative inability of shallow footings to resist inclined, lateral, or uplift loads and overturning moments. Deep foundations resist uplift loads by shaft resistance, Figure 9-1(c). Lateral loads are resisted either by vertical deep foundations in bending, Figure 9-1(d), or by groups of vertical and battered foundations, which combine the axial and lateral resistances of all deep foundations in the group, Figure 9-1(e). Lateral loads from overhead highway signs and noise walls may also be resisted by groups of deep foundations, Figure 9-1(f).
- Deep foundations are often required when scour around footings could cause loss of bearing capacity at shallow depths, Figure 9-1(g). In this case the deep foundations must extend below the depth of scour and develop the full capacity in the support zone below the level of expected scour. FHWA (2001c) scour guidelines require the geotechnical analysis of bridge foundations to be performed on the basis that all stream bed materials in the scour prism have been removed and are not available for bearing or lateral support. Costly damage and the need for future underpinning can be avoided by properly designing for scour conditions.

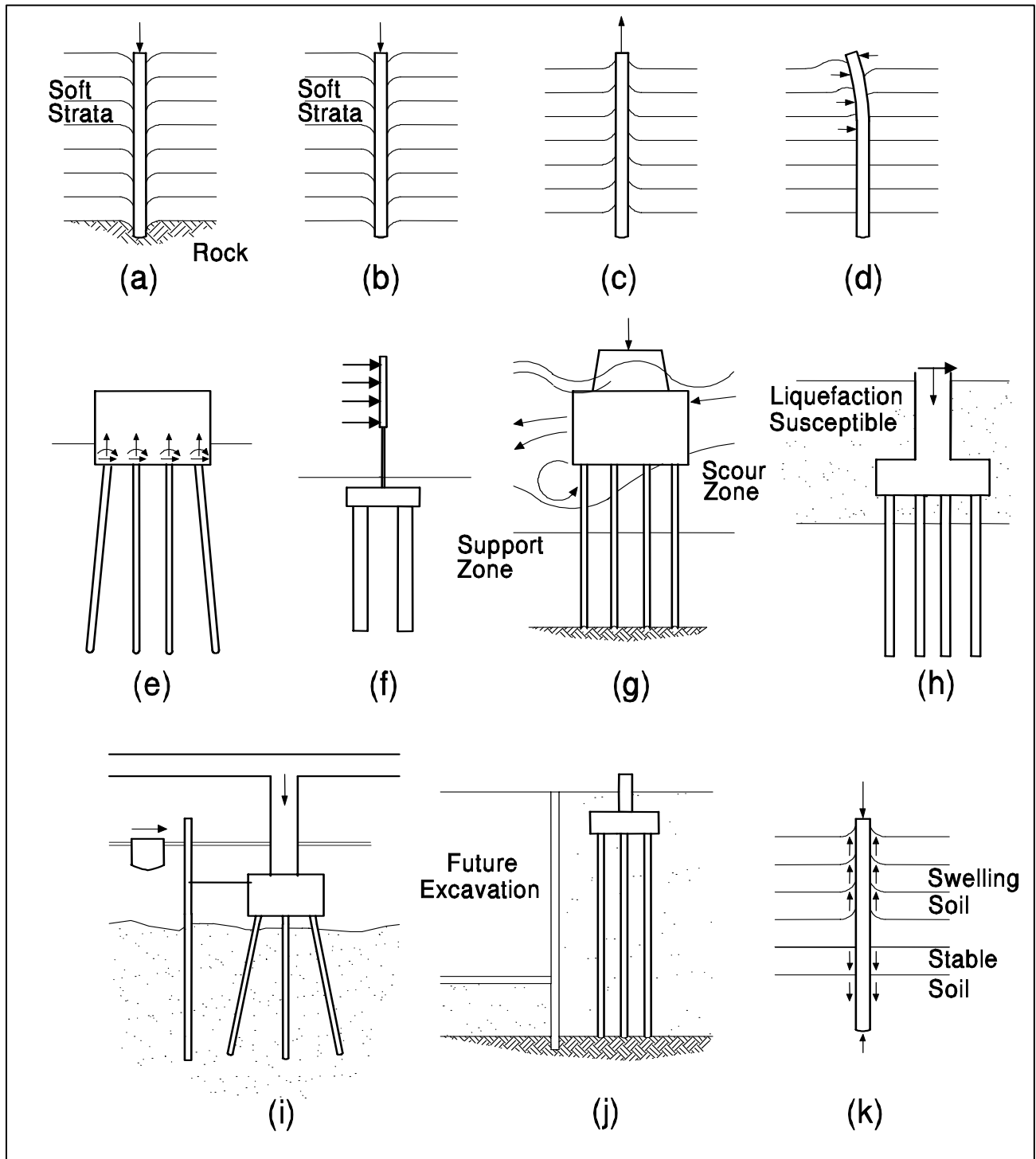

**Figure 9-1. Situations in which deep foundations may be needed (Vesic, 1977; FHWA, 2006a).**

- Soils subject to liquefaction in a seismic event may also dictate that a deep foundation be used, Figure 9-1(h). Seismic events can induce significant lateral loads to deep foundations. During a seismic event, liquefaction-susceptible soils offer less lateral resistance as well as reduced shaft resistance to a deep foundation. Liquefaction effects on deep foundation performance must be considered for deep foundations in seismic areas.
- Deep foundations are often used as fender systems to protect bridge piers from vessel impact, Figure 9-1(i). Fender system sizes and group configurations vary depending upon the magnitude of vessel impact forces to be resisted. In some cases, vessel impact loads must be resisted by the bridge pier foundation elements. Single deep foundations may also be used to support navigation aids.
- In urban areas, deep foundations may occasionally be needed to support structures adjacent to locations where future excavations are planned or could occur, Figure 9-1(j). Use of shallow foundations in these situations could require future underpinning in conjunction with adjacent construction.
- Deep foundations are used in areas of expansive or collapsible soils to resist undesirable seasonal movements of the foundations. Deep foundations under such conditions are designed to transfer foundation loads, including uplift or downdrag, to a level unaffected by seasonal moisture movements, Figure 9-1(k).

## 9.1 TYPES OF DEEP FOUNDATIONS AND PRIMARY REFERENCES

There are numerous types of deep foundations. Figure 9-2 shows a deep foundation classification system based on type of material, configuration, installation technique and equipment used for installation. This chapter discusses the driven pile and drilled shaft foundation types based on the information in the following primary references:

FHWA (2006a) *Design and Construction of Driven Pile Foundations - Vol. I and II*, Report No. FHWA-NHI-05-042 and FHWA-NHI-05-043, Authors: Hannigan, P.J., G.G. Goble, G. Thendean, G.E. Likins and F. Rausche., Federal Highway Administration, U.S. Department of Transportation.

FHWA (1999). *Drilled Shafts: Construction Procedures and Design Methods*. Report No. FHWA-IF-99-025, Authors: O’Neill, M. W. and Reese, L. C. Federal Highway Administration, U.S. Department of Transportation.

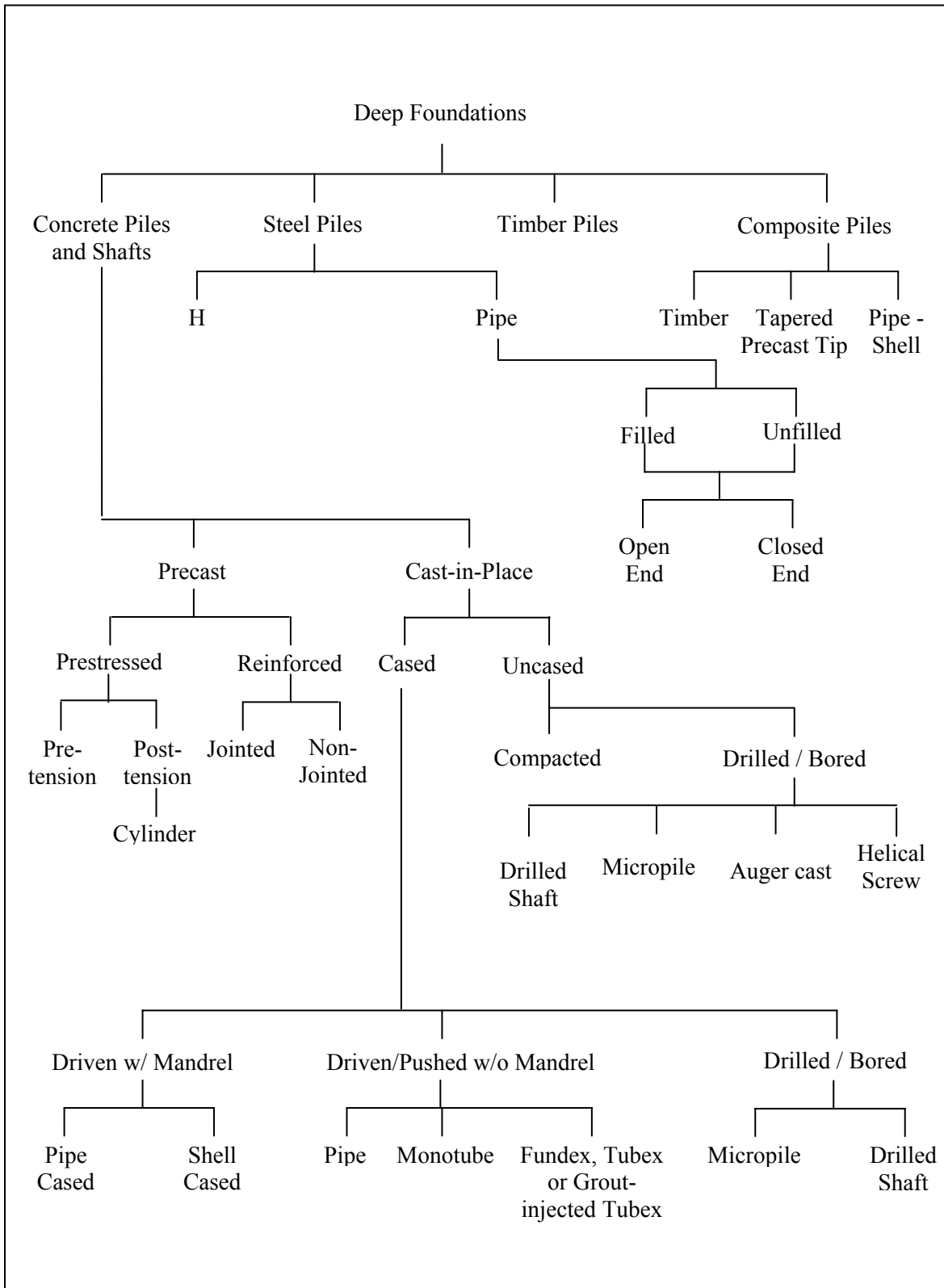

**Figure 9-2. Deep foundation classification system (after FHWA, 2006a).**

Micropiles and auger-cast piles are rapidly gaining in popularity as viable types of deep foundations for transportation structures. These types of piles are not addressed in this chapter. Guidance for these types of piles can be found in the following FHWA manuals.

FHWA (2005a). “Micropile Design and Construction,” Report No. FHWA NHI-05-039, Authors: Sabatini, P.J., Tanyu, B., Armour., P., Groneck, P., and Keeley, J., National Highway Institute, Federal Highway Administration, U.S. Department of Transportation.

FHWA (2006c) “Geotechnical Engineering Circular No. 8, Continuous Flight Auger Piles,” Authors: Brown, D. and Dapp, S., Federal Highway Administration, U.S. Department of Transportation.

### **9.1.1 Selection of Driven Pile or Cast-in-Place (CIP) Pile Based on Subsurface Conditions**

For many years the use of a deep foundation has meant security to many designers. For example, the temptation to use driven piles under every facility is great because detailing of plans is routine, quantity estimate is neat, and safe structural support is apparently assured. Often, designers do not consider other pile alternatives such as cast-in-place (CIP) piles. Figure 9-2 shows a variety of CIP pile types. The most common CIP pile type is the drilled shaft which, as indicated earlier, is the only CIP pile type discussed in this chapter. The selection of appropriate pile types for any project should include a consideration of subsurface conditions as the first step. Table 9-1 provides a discussion of driven pile versus drilled shafts for various subsurface conditions. Sections 9.2 to 9.9 discuss the details of the driven pile foundation systems while Sections 9.10 to 9.14 discuss the CIP pile types with emphasis on drilled shafts.

### **9.1.2 Design and Construction Terminology**

Just as with the design of other geotechnical features, there is a specific terminology associated with design of various deep foundations. Examples of terminology are “static pile capacity,” “ultimate pile capacity,” “allowable pile capacity,” “driving capacity,” “restrike capacity,” “shaft resistance in piles,” “side resistance in drilled shafts,” “toe resistance for piles,” “base or tip resistance for drilled shafts,” etc. This terminology has been ingrained in the technical literature, FHWA manuals, various text books and AASHTO. Herein, the terminology in various primary references listed above will be used for driven piles and drilled shafts. The first time a specific phrase or term appears in the text, it will be highlighted in **bold text**.

For all deep foundations, the capacity of the foundation is a function of the geotechnical and the structural aspects. The geotechnical aspect is a function of the resistance from the ground while



the structural aspect is a function of the structural section and the structural properties of the pile. In this chapter, the primary emphasis is on the geotechnical aspects of the deep foundations. Structural aspects are discussed only to the extent that they may be relevant, e.g., the structural capacity of a pile relative to the driving stresses induced during the driven pile installation process.

**Table 9-1  
Pile type selection based on subsurface and hydraulic conditions**

<b>Typical Problem</b>	<b>Recommendations</b>
Boulders overlying bearing stratum	Use heavy nondisplacement driven pile with a reinforced tip or manufactured point and include contingent predrilling item in contract. Depending on the size of the boulders, large diameter drilled shaft may be feasible.
Loose cohesionless soil	Use tapered pile to develop maximum skin friction. For drilled shafts, side-support in form of casing or slurry will be required making it costlier than the driven pile option
Negative shaft resistance	Use smooth steel pile to minimize drag adhesion, and avoid battered piles. Minimize the magnitude of drag force when possible. In case of drilled shafts use casing to minimize drag load.
Deep soft clay	Use rough concrete pile to increase adhesion and rate of pore water dissipation. Drilled shaft is possible but side-support in form of casing or slurry will be required making it costlier than driven pile option.
Artesian Pressure	Do not use mandrel driven thin-wall shells as generated hydrostatic pressure may cause shell collapse; pile heave common to closed-end pipe. In case of drilled shaft, a slurry drilling will be required.
Scour	Do not use tapered piles unless large part of taper extends well below scour depth. Design permanent pile capacity to mobilize soil resistance below scour depth. Large drilled shaft is likely a better option compared to a group of piles.
Coarse Gravel Deposits	Use precast concrete piles where hard driving expected in coarse soils. DO NOT use H-piles or open end pipes as nondisplacement piles will penetrate at low blow count and cause unnecessary overruns. Drilled shaft is likely a better option for coarse gravel deposit.

## 9.2 DRIVEN PILE DESIGN-CONSTRUCTION PROCESS

The driven pile design and construction process has aspects that are unique in all of structural design. Because the driving characteristics are related to pile capacity for most soils, they can be used to improve the accuracy of the pile capacity estimate. In general, the various methods of determining pile capacity from dynamic data such as driving resistance with wave equation analysis and dynamic measurements are considerably more accurate than the static analysis methods based on subsurface exploration information. **It must be clearly understood that the static analysis based on the subsurface exploration information usually has the function of providing an *estimate* of the pile length prior to field installation. The final driving criterion is usually a blow count that is established after going to the field and the individual pile penetrations may vary depending on the soil variability. Furthermore, pile driveability is a very important aspect of the process and must be considered during the design phase.**

*The key point to understand in a driven pile design is that the pile should be designed such that it (a) can be driven to the design depth without damage, and (b) sustain the loads with the design factor of safety during the service life of the structure.* If the design is completed and the piles cannot be driven, large costs can be generated. It is absolutely necessary that the design and construction phases be linked in a way that does not exist elsewhere in construction.

The driven pile design-construction process is outlined in the flow chart of Figure 9-3. This flow chart will be discussed block by block using the numbers in the blocks as a reference and it will serve to guide the designer through all of the tasks that must be completed.

### **Block 1: Establish Global Project Performance Requirements**

The first step in the entire process is to determine the general structure requirements.

1. Is the project a new bridge, a replacement bridge, a bridge renovation, a retaining wall, a noise wall, or sign or light standard?
2. Will the project be constructed in phases or all at one time?
3. What are the general structure layout and approach grades?
4. What are the surficial site characteristics?

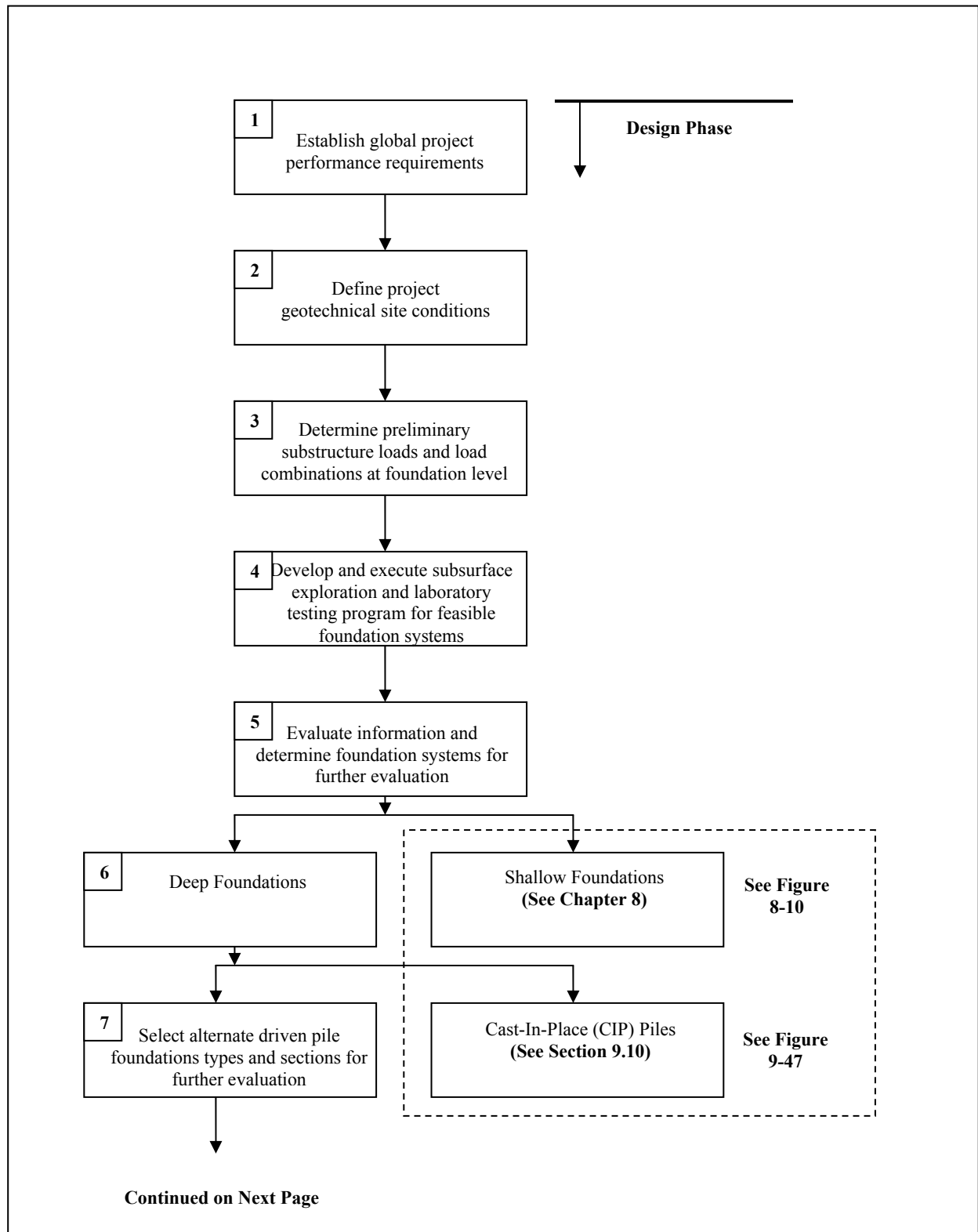

**Figure 9-3. Driven pile design and construction process (after FHWA 2006a).**

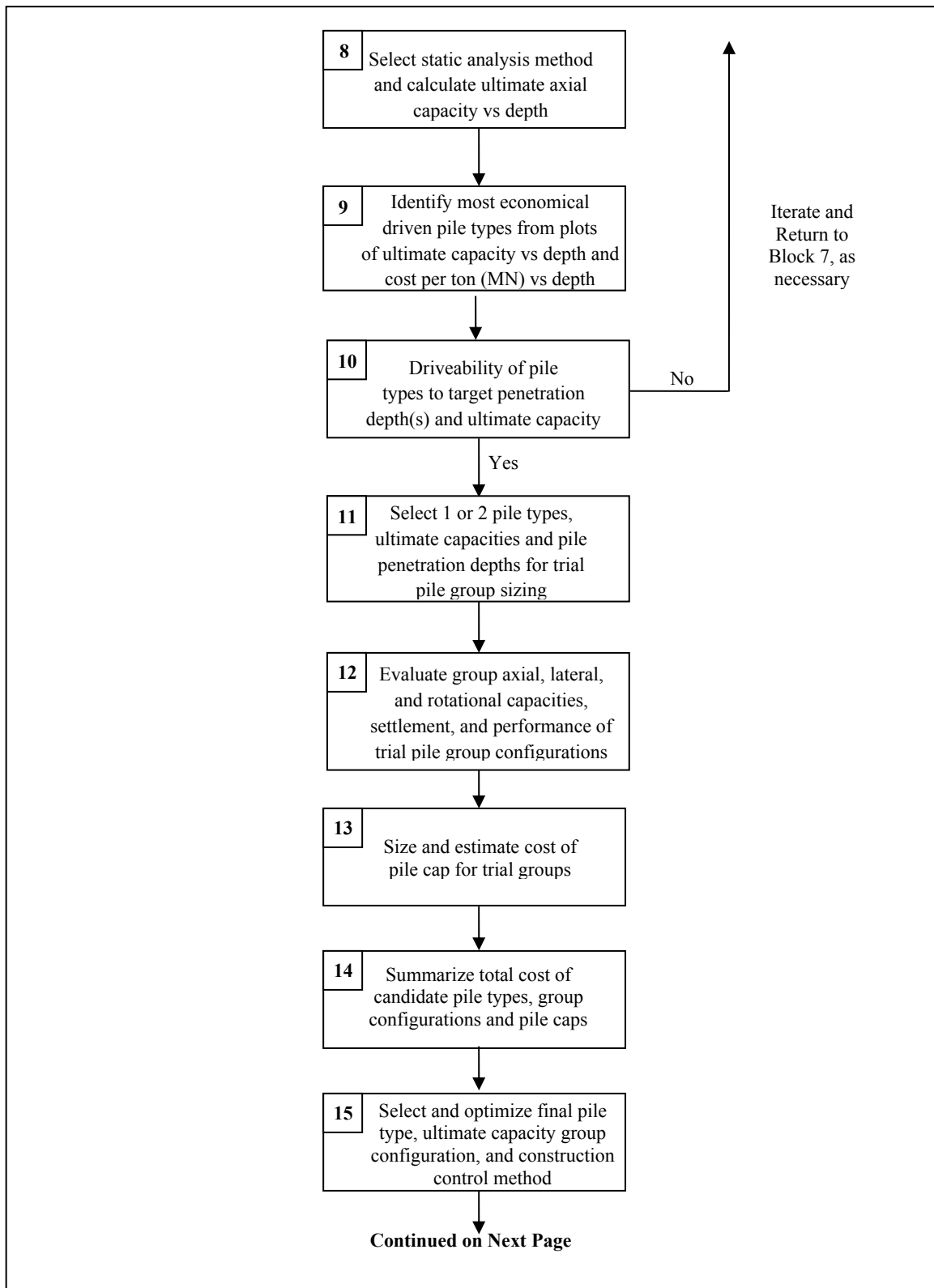

**Figure 9-3 (Continued). Driven pile design and construction process (after FHWA 2006a).**

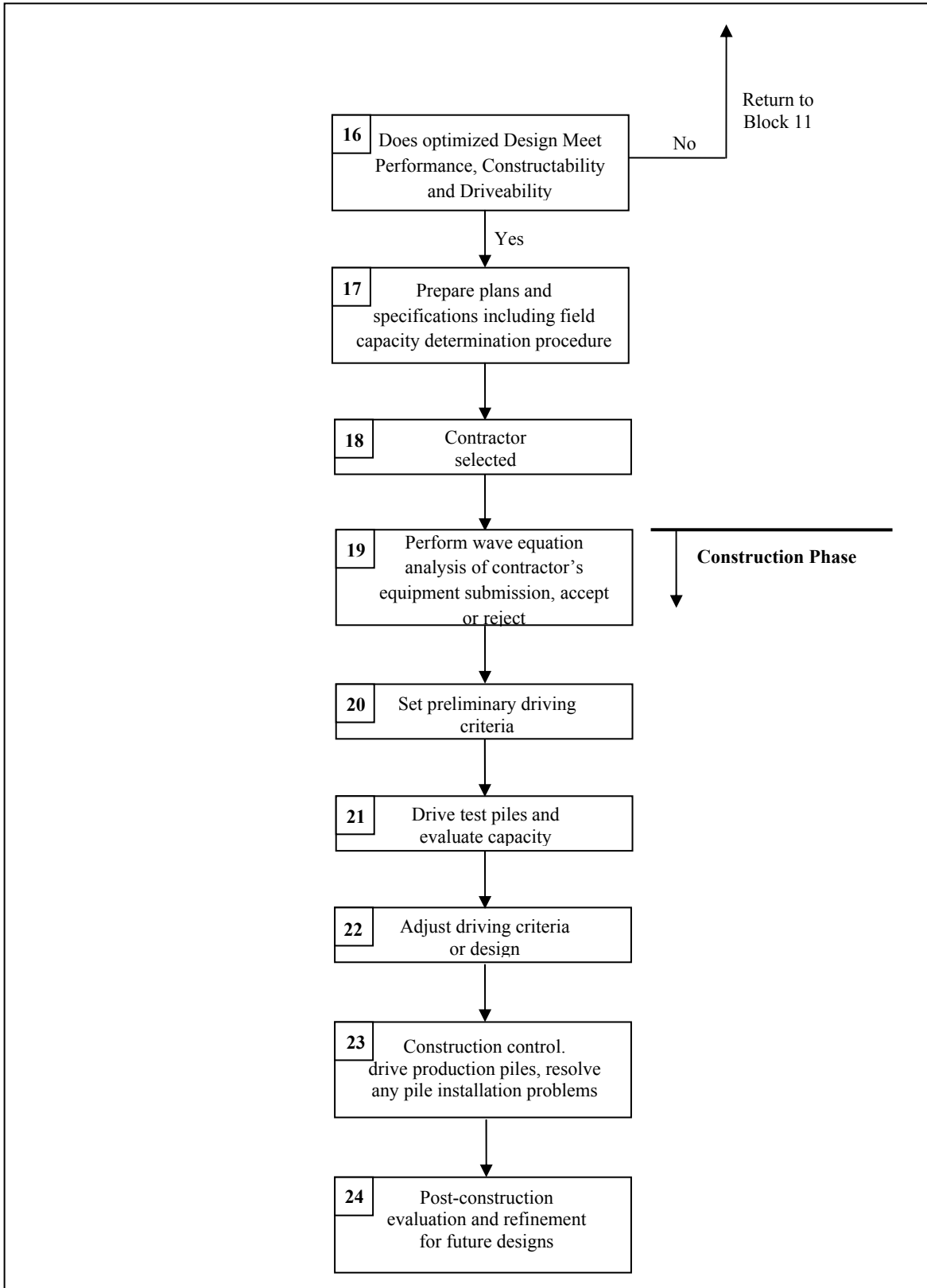

**Figure 9-3 (Continued). Driven pile design and construction process (after FHWA 2006a).**

5. Is the structure subjected to any special design events such as seismic, scour, downdrag, debris loading, vessel impact, etc.? If there are special design events, the design requirements should be reviewed at this stage so that these can be factored into the site investigation.
6. What are the approximate foundation loads? What are the deformation or deflection requirements (total settlement, differential settlement, lateral deformations, tolerances)?
7. Are there site environmental issues that must be considered in the design (specific limitation on noise, vibrations, etc.)?

### **Block 2: Define Project Geotechnical Site Conditions**

A great deal can be learned about the foundation requirements with even a very general understanding of the site geology. For small structures, this may involve only a very superficial investigation such as a visit to the site. The foundation design for very large structures may require extensive geologic studies and review of geologic maps. Based on the geologic studies, the project team should consider possible modifications in the structure that may be desirable for the site under consideration

Frequently there is information available on foundations that have been constructed in the area. This information can be of assistance in avoiding problems. Both subsurface exploration information and foundation construction experience should be collected *prior* to beginning the foundation design. Unfortunately, this step is not often done in practice.

### **Block 3: Determine Preliminary Substructure Loads and Load Combinations at the Foundation Level**

Substructure loads and reasonable vertical and lateral deformation requirements should be established at this time. This issue was considered in Block 1. The result of that effort has probably matured in the intervening time which might be quite long for some projects and is now better defined. It is imperative that the foundation specialist obtain a completely defined and unambiguous set of foundation loads and performance requirements in order to proceed through the foundation design process. Accurate load information and performance criteria are essential in the development and implementation of an adequate subsurface exploration program for the planned structure.

#### **Block 4: Develop and Execute Subsurface Exploration Program for Feasible Foundation Systems**

Based on the information obtained in Blocks 1-3, it is possible to make decisions regarding the necessary information that must be obtained for the feasible foundation systems at the site. The subsurface exploration program and the associated laboratory testing must meet the needs of the design problem that is to be solved at a cost consistent with the size and importance of the structure. The results of the subsurface exploration program and the laboratory testing are used to prepare a subsurface profile and identify critical cross sections. These tasks are covered in greater detail in Chapters 3, 4, and 5.

#### **Block 5: Evaluate Information and Select Candidate Foundation Systems**

The information collected in Blocks 1-4 must be evaluated and candidate foundation systems selected for further consideration. The first question to be decided is whether a shallow or a deep foundation is required. This question will be answered based primarily on the strength and compressibility of the site soils, the proposed loading conditions, scour depth, the project performance criteria and the foundation cost. If settlement and scour are not a problem for the structure, then a shallow foundation will probably be the most economical solution. Ground improvement techniques in conjunction with shallow foundations should also be evaluated. Shallow and deep foundation interaction with approach embankments must also be considered. If the performance of a shallow foundation exceeds the limitations imposed by the structure performance criteria, a deep foundation must be used. The design of ground improvement techniques is not covered in this manual and can be found in FHWA (2006b). Information on design considerations for shallow foundations can be found in Chapter 8.

#### **Block 6: Deep Foundations**

The decision on deep foundation type is now between driven piles and other deep foundation systems. These other deep foundation systems are primarily drilled shafts, but would also include micropiles, auger cast piles, and other drilled-in deep foundation systems as shown in Figure 9-2. The questions that must be answered in deciding between driven piles and other deep foundation systems will center on the relative costs of available, possible systems. Foundation support cost can be conveniently calculated based on a cost per unit of load carried. In addition, constructability must be considered. Design guidance on drilled shafts can be found in Section 9.10 of this chapter. Guidance for other deep foundation systems such as micro-piles and auger cast piles can be found in the references listed in Section 9.1.

## **Block 7: Select Candidate Driven Pile Types for Further Evaluation**

At this point on the flow chart, the primary concern is for the design of a driven pile foundation. The pile type must be selected consistent with the applied load per pile. Consider this problem. The general magnitude of the column or pier loads is known from the information obtained in Blocks 1 and 3. However, a large number of combinations of pile capacities and pile types can satisfy the design requirements. Should twenty, 225 kip (1000 kN) capacity piles be used to carry a 4,500 kip (20,000 kN) load, or would it be better to use ten, 450 kip (2,000 kN) capacity piles? This decision should consider both the structural capacity of the pile and the realistic geotechnical capacities of the pile type for the soil conditions at the site, the cost of the available alternative piles, and the capability of available construction contractors to drive the selected pile. Of course, there are many geotechnical factors that must also be considered. At this point in the design process, 2 to 5 candidate pile types and/or sections that meet the general project requirements should be selected for further evaluation. Pile type and selection considerations are covered in Section 9.3.

At this stage the loads must also be firmly established. In Block 1, approximate loads were determined, which were refined in Block 3. At the early stages of the design process the other aspects of the total structural design were probably not sufficiently advanced to establish the final design loads. By the time that Block 6 has been reached, the structural engineer should have finalized the various loads. One common inadequacy that is sometimes discovered when foundation problems arise is that the foundation loads were never really accurately defined at the final stage of the foundation design.

If there are special design events to be considered, they must be included in the determination of the loads. Vessel impact will be evaluated primarily by the structural engineer and the results of that analysis will give pile loads for that case. There may be stiffness considerations in dealing with vessel impact since the design requirement is basically a requirement that some vessel impact energy be absorbed by the foundation system.

Scour presents a different requirement. The loads due to the forces from the stream must be determined as specified in the AASHTO (2002), Section 3.18. The requirements of this AASHTO section should be included in the structural engineer's load determination process. The depth of scour must also be determined as directed in AASHTO (2002), Section 4.3.5. In the design process, it must be assured that the pile will still have adequate capacity after scour.

In many locations in the country, seismic loads will be an important contributor to some of the critical pile load conditions. Since the 1971 San Fernando Earthquake, significant emphasis has



been placed on seismic design considerations in the design of highway bridges. The AASHTO Standard Specifications for Highway Bridges has been substantially expanded to improve the determination of the seismic loads. Usually the structural engineer will determine the seismic requirements. Frequently the behavior of the selected pile design will affect the structural response and hence the pile design loads. In this case, there will be another loop in the design process that includes the structural engineer. The geotechnical engineer should review the seismic design requirements in Division I-A of AASHTO (2002) for a general understanding of the design approach.

**Block 8:      Select Static Analysis Method and Calculate Ultimate Capacity vs Depth**

A static analysis method(s) applicable to the pile type(s) under consideration and the soil conditions at the site should now be selected. Static analysis methods are covered in detail in Section 9.4. The ultimate axial capacity versus depth should then be calculated for all candidate pile types and sections.

**Block 9:      Identify Most Economical Candidate Pile Types and/or Sections**

The next step is to develop and evaluate plots of the ultimate axial static capacity versus pile penetration depth and the pile support cost versus pile penetration depth for each candidate pile type and/or section. The support cost, which is the cost per ton (kN) supported, is the ultimate capacity at a given penetration depth divided by the pile cost to reach that penetration depth. The pile cost can be calculated from the unit cost per ft (m) multiplied by the pile length to the penetration depth. These plots should be evaluated to identify possible pile termination depths to obtain the lowest pile support cost. This process is briefly discussed in Section 9.3.

**Block 10:     Calculate Driveability of Candidate Pile Types**

Candidate pile types should now be evaluated for driveability. Can the candidate pile type and/or section be driven to the required capacity and penetration depth at a reasonable pile penetration resistance (blow count) without exceeding allowable driving stresses for the pile material? This analysis is performed by using the wave equation theory. All of the necessary information is available except the hammer selection. Since the hammer to be used on the job will be known only after the contractor is selected, possible hammers must be identified to make sure that the pile is driveable to the capacity and depth required.

Pile driveability, wave equation analysis and allowable pile driving stresses are discussed in Section 9.9.

If candidate pile types or sections do not meet driveability requirements they are dropped from further evaluation or modified sections must be chosen and evaluated. For H-piles and pipe piles it may be possible to increase the pile section without increasing the soil resistance to driving. For concrete piles an increase in section usually means a larger pile size. Therefore, an increase in soil resistance must also be overcome. Hence, some section changes may cause the design process to revisit Block 8. If all candidate pile types fail to meet driveability requirements, the design process must return to Block 7 and new candidate pile types must be selected.

**Block 11: Select 1 or 2 Final Candidate Pile Types for Trial Group Sizing**

The most viable candidate pile types and/or sections from the cost and driveability evaluations in Blocks 9 and 10 should now be evaluated for trial group sizing by using the final loads and performance requirements. Multiple pile penetration depths and the resulting ultimate capacity at those depths should be used to establish multiple trial pile group configurations for each candidate pile type. These trial configurations should then be carried forward to Block 13.

**Block 12: Evaluate Capacity, Settlement, and Performance of Trial Groups**

The trial group configurations should now be evaluated for axial group capacity, group uplift, group lateral load performance, and settlement. These computations and analysis procedures are described in Section 9.6.

**Block 13: Size and Estimate Pile Cap Cost for Trial Groups**

The size and thickness of the pile cap for each trial group should be evaluated, and the resulting pile cap cost estimated. It is not necessary to design the cap reinforcement at this time only to determine cap size. Pile cap cost is a key component in selecting the most cost effective pile type and should not be overlooked.

**Block 14: Summarize Total Cost of Final Candidate Piles**

The total cost of each candidate pile should now be determined. A given pile type may have several total cost options depending upon the pile penetration depths, ultimate capacities, group configurations, and pile cap sizes carried through the design process. The cost of any special construction considerations and environmental restrictions should also be included in the total cost for each candidate pile.

### **Block 15: Select and Optimize Final Pile Type, Capacity, and Group Configuration**

Select the final pile foundation system including pile type, section, length, ultimate capacity and group configuration for final design. A complete evaluation of lateral and rotational resistance of the group should be performed. The design should be optimized for final structure loads, performance requirements, and construction efficiency.

### **Block 16: Does Optimized Design Meet All Requirements?**

The final pile type, section, capacity and group configuration optimized in Block 15 should be evaluated so that all performance requirements have been achieved. If the optimization process indicates that a reduced pile section can be used, the driveability of the optimized pile section must be checked by a wave equation driveability analysis. This analysis should also consider what influence the group configuration and construction procedures (e.g., cofferdams, etc.) may have on pile installation conditions.

### **Block 17: Prepare Plans and Specifications, Set Field Capacity Determination Procedure**

When the design has been finalized, plans and specifications can be prepared and the procedures that will be used to verify pile capacity can be defined. It is important that all of the quality control procedures are clearly defined for the bidders to avoid claims after construction is underway. In the past a pile load specified on the basis of dynamic formulae was a design or working load since a factor of safety is contained in the formula. Modern methods for determining pile capacity always use ultimate loads with a factor of safety (or in LRFD a resistance factor) selected and applied. This modern approach should also be made clear in the project specifications so that the contractor has no question regarding the driving requirements. Procedures should be in place that address commonly occurring pile installation issues such as obstructions and driveability.

### **Block 18: Contractor Selection**

After the bidding process is complete, a contractor is selected. The contractor should be qualified and experienced in the installation of driven piles for the type of structure being built.

### **Block 19: Perform Wave Equation Analysis of Contractor's Equipment Submission**

At this point the engineering effort shifts to the field. The contractor will submit a description of the pile driving equipment that he intends to use on the project for the engineer's evaluation. Wave equation analyses are performed to determine the driving resistance that must be achieved in the field to meet the required capacity and pile penetration depth. Driving stresses are determined and evaluated. If all conditions are satisfactory, the equipment is approved for driving. Some design specifications make this information advisory to the contractor rather than mandatory. Section 9.8 provides additional information in this area.

On smaller projects, a dynamic formula may be used to evaluate driveability. In this case, the modified Gates Formula should be used. If a dynamic formula is used, then driveability and hammer selection will be based on the driving resistance given by the formula only, since stresses are not determined. Dynamic formula usage is covered in Section 9.9.

### **Block 20: Set Preliminary Driving Criteria**

Based on the results of the wave equation analysis of Block 19 (or on smaller projects the modified Gates Formula) and any other requirements in the design, the preliminary driving criteria can be set.

### **Block 21: Drive Test Pile and Evaluate Capacity**

The test pile(s), if required, are driven to the preliminary criteria developed in Block 19. Driving requirements may be defined by penetration depth, driving resistance, dynamic monitoring results or a combination of these conditions. The capacity can be evaluated by driving resistance from wave equation analysis, the results of dynamic monitoring, static load test, the modified Gates Formula, or a combination of these. Dynamic monitoring is described in Section 9.9. Static load test procedures are discussed in greater detail at the end of this chapter.

### **Block 22: Adjust Driving Criteria or Design**

At this stage the final conditions can be set or, if test results from Block 21 indicate the capacity is inadequate, the driving criteria may have to be changed. In a few cases, it may be necessary to make changes in the design that will return the process as far back as Block 8.

In some cases, it is desirable to perform preliminary field testing before final design. When the job is very large and the soil conditions are difficult, it may be possible to achieve substantial

cost savings by having results from a design stage test pile program, including actual driving records at the site, as part of the bid package.

**Block 23: Construction Control**

After the driving criteria are set, the production pile driving begins. Quality control and assurance procedures have been established and are applied. Problems may arise and must be handled as they occur in a timely fashion.

**Block 24: Post-Construction Evaluation and Refinement of Design**

After completion of the foundation construction, the design should be reviewed and evaluated for its effectiveness in satisfying the design requirements and also its cost effectiveness.

**9.3 ALTERNATE DRIVEN PILE TYPE EVALUATION**

The selection of appropriate driven pile types for any project involves the consideration of several design and installation factors including pile characteristics, subsurface conditions and performance criteria. This selection process should consider the factors listed in Table 9-1, Table 9-2 and Table 9-3. Table 9-2 summarizes typical pile characteristics and uses. Table 9-3 presents the placement effects of pile shape characteristics.

**Table 9-2  
Typical piles and their range of loads and lengths**

<b>Type of Pile</b>	<b>Typical Axial Design Loads</b>	<b>Typical Lengths</b>
Timber	20-110 kips (100 – 500 kN)	15-120 ft (5-37 m)*
Precast / Prestressed Reinforced Concrete	90-225 kips (400-1,000 kN) for reinforced 90-1000 kips (400-4,500 kN) for prestressed	30-50 ft (10-15m) for reinforced 50-130 ft (15-40m) for prestressed
Steel H	130-560 kips (600-2,500 kN)	15-130 ft (5-40 m)
Steel Pipe (without concrete core)	180-560 kips (800-2,500 kN)	15-130 ft (5-40 m)
Steel Pipe (with concrete core)	560-3400 kips (2,500-15,000 kN)	15-130 ft (5-40 m)
* 15-75 ft (5-23 m) for Southern Pine; 15-120 ft (5-37 m) for Douglas Fir		

**Table 9-3  
Pile type selection pile shape effects**

<b>Shape Characteristics</b>	<b>Pile Types</b>	<b>Placement Effects</b>
Displacement	Steel Pipe (Closed end), Precast Concrete	<ul style="list-style-type: none"> <li>• Increase lateral ground stress</li> <li>• Densify cohesionless soils, remolds and weakens cohesive soils temporarily</li> <li>• Set-up time may be 6 months in clays for pile groups</li> </ul>
Nondisplacement	Steel H, Steel Pipe (Open end)	<ul style="list-style-type: none"> <li>• Minimal disturbance to soil</li> <li>• Not suited for friction piles in coarse granular soils. Piles often have low driving resistances in these deposits making field capacity verification difficult thereby often resulting in excessive pile lengths.</li> </ul>
Tapered	Timber, Monotube, Tapertube, Thin-wall shell	<ul style="list-style-type: none"> <li>• Increased densification of soils with less disturbance, high capacity for short length in granular soils</li> </ul>

In addition to the considerations provided in the Tables 9-1, 9-2 and 9-3, the problems posed by the specific project location and topography must be considered in any pile selection process. Following are some of the problems usually encountered:

1. Noise and vibration from driven pile installation may affect pile type selection, and require special techniques such as predrilling and/or vibration monitoring of adjacent structures.
2. Remote areas may restrict driving equipment size and, therefore, pile size.
3. Local availability of certain materials and the capability of local contractors may have decisive effects on pile selection.
4. Waterborne operations may dictate use of shorter pile sections due to pile handling limitations.
5. Steep terrain may make the use of certain pile equipment costly or impossible.

### **9.3.1 Cost Evaluation of Alternate Pile Types**

Often several different pile types meet all the requirements for a particular structure. In such cases, the final choice should be made on the basis of a cost analysis that assesses the over-all cost of the foundation alternatives. This requires that candidate pile types be

carried forward in the design process for determination of the pile section requirements for design loads and constructability. The cost analysis for the candidate pile types should include uncertainties in execution, time delays, cost of load testing programs, as well as the differences in the cost of pile caps and other elements of the structure that may differ among alternatives. For major projects, alternate foundation designs should be considered for inclusion in the contract documents if there is a potential for cost savings.

For driven pile foundation projects, the total foundation cost can be separated into three major components as follows:

- The pile cost
- The pile cap cost, and
- The construction control method cost

For most pile types, the pile cost can usually be assumed as linear with depth based on unit price. However, this may not be true for very long concrete piles or long, large section steel piles. These exceptions may require the cost analysis to reflect special transportation, handling, or splicing costs for concrete piles or extra splice time and cost for steel piles. Table 9-4 presents cost savings recommendations to be considered during the evaluation of pile foundations. Expressing the cost of candidate pile types in terms of dollars per ton capacity would allow comparison of alternative pile types in a rational manner. Details of this approach, i.e., expressing costs in \$/ton, are presented in FHWA (2006a).

#### **9.4 COMPUTATION OF PILE CAPACITY**

Once the allowable structural load has been determined for prospective pile alternates, the pile length required to support that load must be determined. For many years this length determination was considered part of the "art of foundation engineering." In recent years more rational analytic procedures have been developed. Static analyses provide a useful design tool to select the most economical pile alternates. The methods that follow are established procedures that account for the variables in pile length determination. The "art" remains in selecting appropriate soil strength values for the conditions and ascertaining the effects of pile installation on these values. For the typical project two static analyses will be required; the first to determine the length required for permanent support of the structures, and the second to determine the soil resistance to be overcome during driving to achieve the estimated length. It must be stressed that each new site represents a new problem with unique conditions. Experience with similar sites should not replace but should refine the rational analysis methods presented herein. This section discusses the concept of static capacity of the pile based on a rational approach.

**Table 9-4. Cost savings recommendations for pile foundations (FHWA, 2006a)**

Factor	Inadequacy of Older Methods	Cost Saving Recommendations	Remarks
A. Design structural load capacity of piles.	1. Allowable pile material stresses may not address site-specific considerations.	1. Use realistic allowable stresses for pile materials in conjunction with adequate construction control procedures, (i.e., load testing, dynamic pile monitoring and wave equation). 2. Determine potential pile types and carry candidate pile types forward in the design process. 3. Optimize pile size for loads.	1. Rational consideration of Factors A and B may decrease cost of a foundation by 25 percent or more. 2. Significant cost savings can be achieved by optimization of pile type and section for the structural loads with consideration of pile driveability requirements.
B. Design geotechnical capacity of soil and rock to carry load transferred by piles.	1. Inadequate subsurface explorations and laboratory testing. 2. Rules of thumb and prescribed values used in lieu of static design may result in overly conservative designs. 3. High potential for change orders and claims.	1. Perform thorough subsurface exploration including in-situ and laboratory testing to determine design parameters. 2. Use rational and practical methods of design. 3. Perform wave equation driveability analysis. 4. Use design stage pile load testing on large pile driving projects to determine load capacities (load tests during design stage).	1. Reduction of safety factor can be justified because some of the uncertainties about load carrying capacities of piles are reduced. 2. Rational pile design will generally lead to shorter pile lengths and/or smaller number of piles.
C. Alternate foundation design.	1. Alternate foundation designs are rarely used even when possibilities of cost savings exist by allowing alternates in contract documents.	1. For major projects, consider inclusion of alternate foundation designs in the contract documents if estimated costs of feasible foundation alternatives are within 15 percent of each other.	1. Alternative designs often generate more competition which can lead to lower costs.
D. Plans and specifications.	1. Unrealistic specifications. 2. Uncertainties due to inadequate subsurface explorations force the contractors to inflate bid prices.	1. Prepare detailed contract documents based on thorough subsurface explorations, understanding of contractors' difficulties and knowledge of pile techniques and equipment. 2. Provide subsurface information to the contractor.	1. Lower bid prices will result if the contractor is provided with all the available subsurface information. 2. Potential for contract claims is reduced with realistic specifications.
E. Construction determination of pile load capacity during installation.	1. Often used dynamic formulas such as Engineering News formula are unreliable. Correlations between load capacities determined from Engineering News formula and static load tests indicate safety factors ranging from less than 1 (i.e. failure) to about 20 (i.e. excessive foundation cost).	1. Eliminate use of dynamic formulas for construction control as experience is gained with the wave equation analysis. 2. Use wave equation analysis coupled with dynamic monitoring for construction control and load capacity evaluation. 3. Use pile load tests on projects to substantiate capacity predictions by wave equation and dynamic monitoring.	1. Reduced factor of safety may allow shorter pile lengths and/or smaller number of piles. 2. Pile damage due to excessive driving can be eliminated by using dynamic monitoring equipment. 3. Increased confidence and lower risk results from improved construction control.



The **static capacity** of a pile can be defined as the sum of soil/rock resistances along the pile shaft and at the pile toe available to support the imposed loads on the pile. Static analyses are performed to determine the ultimate capacity of an individual pile and of a pile group as well as the deformation response of a pile group to the applied loads. The **ultimate capacity** of an individual pile and of a pile group is defined as the smaller of:

- (1) the capacity of the surrounding soil/rock medium to support the loads transferred from the pile(s) or,
- (2) the structural capacity of the pile(s).

Soil-structure interaction analysis methods are used to determine the deformation response of piles and pile groups to lateral loads; such methods can also be used for deformation evaluation under vertical loads. The results from these analyses as well as the results of static analysis of pile group settlement are compared to the performance criteria established for the structure.

The ultimate geotechnical pile capacity,  $Q_u$ , of a pile in homogeneous soil may be expressed as follows in terms of the **shaft (commonly known as “skin”) resistance**,  $R_s$ , **toe resistance**,  $R_t$ , and the weight,  $W$ , of the pile:

$$Q_u = R_s + R_t - W \quad 9-1$$

In most cases, such as H-Piles and open ended pipe piles, the weight  $W$  is small compared to the shaft and toe resistance and is neglected. However, the weight of pipe piles, particularly large diameter pipes, filled with concrete may be significant and may be included in the analysis. In this chapter, the  $W$  term is neglected. Equation 9-1, without the  $W$  term, may also be expressed in the form

$$Q_u = f_s A_s + q_t A_t \quad 9-2$$

where  $f_s$  is the **unit shaft resistance** over the shaft surface area,  $A_s$ , and  $q_t$  is the **unit toe resistance** over the pile toe area,  $A_t$ . The above equations for pile bearing capacity assume that both the pile toe and the pile shaft have moved sufficiently with respect to the adjacent soil to simultaneously develop the ultimate shaft and toe resistances. Generally, the displacement needed to mobilize the shaft resistance is smaller than that required to mobilize the toe resistance. This simple rational approach has been commonly used for all piles except very large diameter piles where such an approach may not be valid.

Figure 9-4 illustrates typical load transfer profiles for a single pile. The load transfer distribution can be obtained from a static load test where strain gages or telltale rods are attached to a pile at different depths along the pile shaft. Figure 9-4 shows the measured ultimate axial load,  $Q_u$ , in the pile plotted against depth. **The shaft resistance transferred to the soil is represented by  $R_s$ , and  $R_t$  represents the resistance at the pile toe.** In Figure 9-4(a), the load transfer distribution for a pile with no shaft resistance is illustrated. In this case the full axial load at the pile head is transferred to the pile toe. In Figure 9-4(b), the axial load versus depth for a uniform shaft resistance distribution typical of a cohesive soil is illustrated. Figure 9-4(c) presents the axial load in the pile versus depth for a triangular shaft resistance distribution typical of cohesionless soils.

#### 9.4.1 Factors of Safety

The results of static analyses yield a **geotechnical ultimate pile capacity**,  $Q_u$ . The **allowable geotechnical soil resistance (geotechnical pile design load)**,  $Q_a$ , is selected by dividing the **geotechnical ultimate pile capacity**,  $Q_u$ , by a **factor of safety** as follows.

$$Q_a = \frac{Q_u}{\text{Factor of Safety}} \quad 9-3$$

The range of the factor of safety, FS, has depended primarily upon the reliability of the particular method of static analysis with consideration of the following items:

1. The level of confidence in the input parameters. The level of confidence is a function of the type and extent of the subsurface exploration and laboratory testing of soil and rock materials.
2. Variability of the soil and rock.
3. Method of static analysis.
4. Effects of and consistency of the proposed pile installation method.
5. Level of construction control (static load test, dynamic analysis, wave equation analysis, Gates dynamic formula).

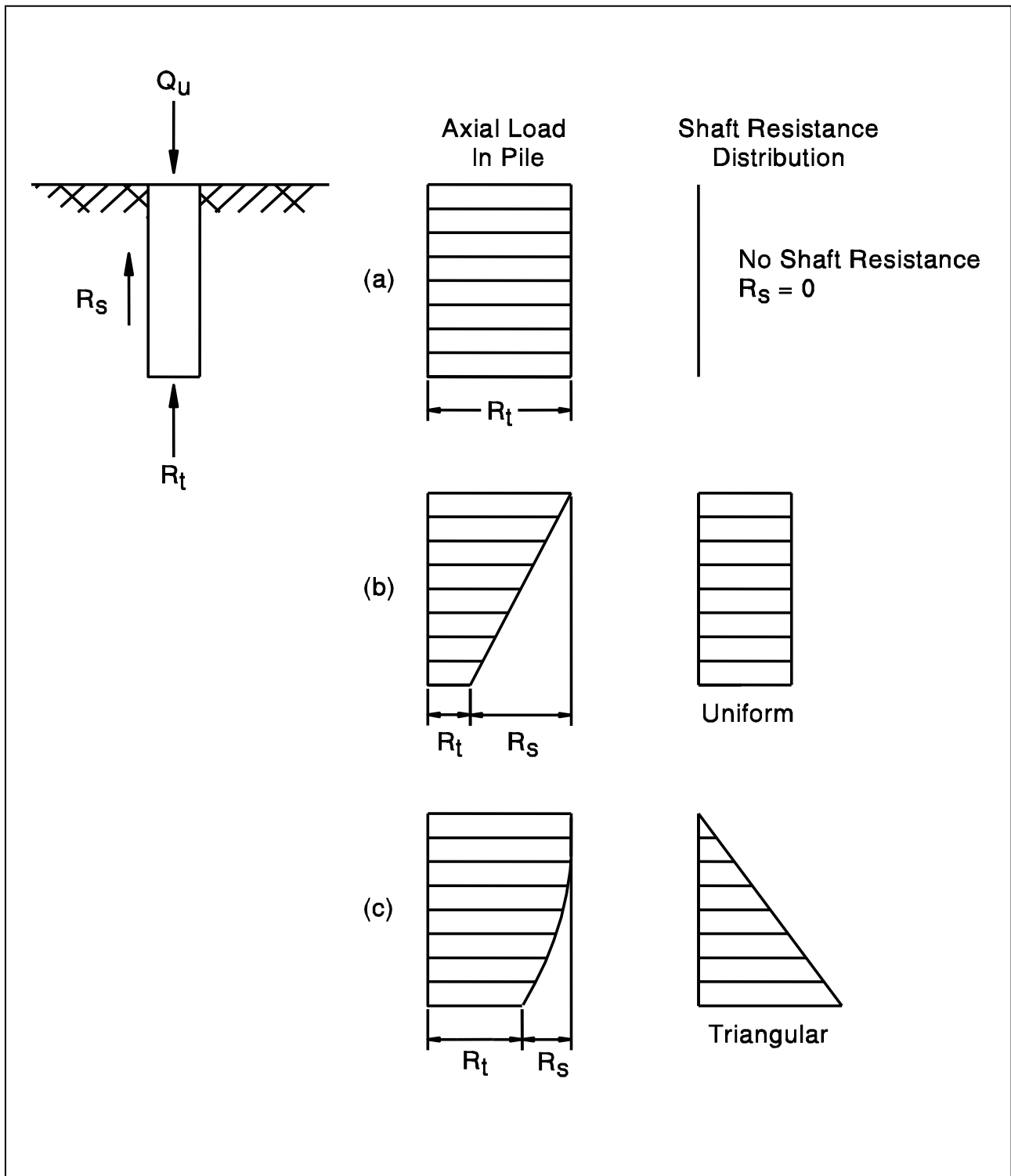

Figure 9-4. Typical load transfer profiles (FHWA, 2006a).

A large number of static analysis methods are documented in the literature with specific recommendations on the factor of safety to be used with each method. These recommended factors of safety have routinely disregarded the influence of the construction control method used to complement the static analysis computation. As part of the overall design process, it is important that the foundation designer qualitatively assess the validity of the chosen design analysis method and the reliability of the geotechnical design parameters.

While the range of static analysis factors of safety in the past was from 2 to 4, most of the static analysis methods recommended a factor of safety of 3. As foundation design loads increased over time, the use of higher factors of safety often resulted in pile installation problems. In addition, experience has shown that construction control methods have a significant influence on pile capacity. Therefore, **the factor of safety used in a static analysis calculation should be based upon the construction control method specified.** Provided that the procedures recommended in this manual are used for the subsurface exploration and analysis, the factors of safety in Table 9-5 are recommended based on the specified construction control method. The factor of safety for other test methods not included in Table 9-5 should be determined by the individual designer.

**Table 9-5. Recommended factor of safety based on construction control method**

<b>Construction Control Method</b>	<b>Factor of Safety</b>
Static load test with wave equation analysis	2.00
Dynamic testing with wave equation analysis	2.25
Indicator piles with wave equation analysis	2.50
Wave equation analysis	2.75
Gates dynamic formula	3.50

The pile design load should be supported by soil resistance developed only in soil layers that contribute to long term load support. The soil resistance from soils subject to scour, or from soil layers above soft compressible soils should not be considered. The following example problem will be used to clarify the use of the factor of safety in static pile capacity calculations for determination of the pile design load as well as for determination of the soil resistance to pile driving.

Consider a pile to be driven through the soil profile described in Figure 9-5. The proposed pile type penetrates through a sand layer subject to scour in the 100-year flood into an underlying very soft clay layer unsuitable for long term support and then into competent support materials. The soil resistances from the scour-susceptible sand layer and soft clay layer do not contribute to long term load support and should not be included in the soil resistance for support of the design load. In this example, static load testing with wave equation analysis will be used for construction control. Therefore, a factor of safety of 2.0 should be applied to the ultimate soil resistance calculated in suitable support layers in the static analysis. It should be noted that this approach is for scour conditions under the 100-year or overtopping flood events and that a different approach would apply for the superflood or 500-year event. For a superflood, a minimum factor of safety of 1.0 is used. This minimum factor of safety is determined by dividing the maximum pile load by the sum of the shaft and toe resistances available below scour depth.

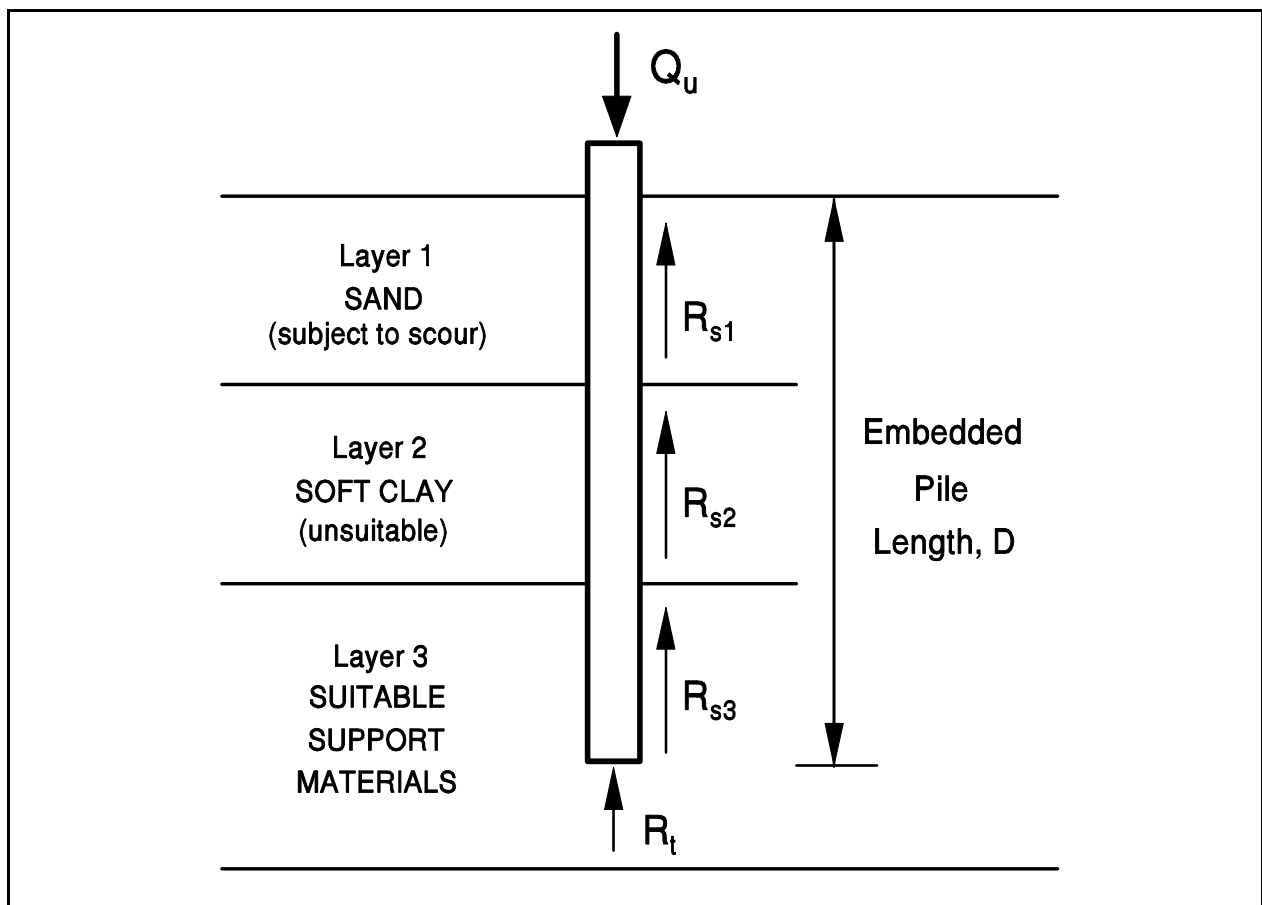

Figure 9-5. Soil profile for factor of safety discussion (FHWA, 2006a).

In the static analysis, a trial pile penetration depth is chosen and an ultimate pile capacity,  $Q_u$ , is calculated. This ultimate capacity includes the soil resistance calculated from all soil layers including the shaft resistance in the scour susceptible layer,  $R_{s1}$ , the shaft resistance in the unsuitable soft clay layer,  $R_{s2}$  as well as the resistance in suitable support materials along the pile shaft,  $R_{s3}$ , and at the pile toe resistance,  $R_t$ .

$$Q_u = R_{s1} + R_{s2} + R_{s3} + R_t$$

The design load,  $Q_a$ , is the sum of the soil resistances from the suitable support materials divided by a factor of safety, FS. As noted earlier, a factor of safety of 2.0 is used in the equation below because of the planned construction control with static load testing. Therefore,

$$Q_a = (R_{s3} + R_t) / (FS=2)$$

The design load may also be expressed as the sum of the ultimate capacity minus the calculated soil resistances from the scour susceptible and unsuitable layers divided by the factor of safety. In this alternative approach, the design load is expressed as follows:

$$Q_a = (Q_u - R_{s1} - R_{s2}) / (FS=2)$$

The result of the static analysis is then the estimated pile penetration depth,  $D$ , the design load for that penetration depth,  $Q_a$ , and the calculated ultimate capacity,  $Q_u$ .

For preparation of construction plans and specifications, the **calculated geotechnical ultimate capacity**,  $Q_u$ , is specified. Note that if the construction control method changes after the design stage, the required ultimate capacity and the required pile penetration depth for the ultimate capacity will also change. This is apparent when the previous equation for the design load is expressed in terms of the ultimate capacity as follows:

$$Q_u = R_{s1} + R_{s2} + (Q_a)(FS=2)$$

A static analysis should also be used to calculate the **soil resistance to driving**, SRD, that must be overcome to reach the estimated pile penetration depth necessary to develop the ultimate capacity. This information is necessary for the designer to select a pile section with the driveability to overcome the anticipated soil resistance and for the contractor to properly size equipment. Driveability aspects of design are discussed in Section 9.9.

In the SRD calculation, a factor of safety is not used. The soil resistance to driving is the sum of the soil resistances from the scour susceptible and unsuitable layers plus the soil resistance in the suitable support materials to the estimated penetration depth.

$$SRD = R_{s1} + R_{s2} + R_{s3} + R_t$$

Soil resistances in this calculation should be the resistance at the time of driving. Hence time dependent changes in soil strengths due to **soil setup or relaxation** should be considered (see Table 5-8 in Chapter 5 for brief explanation of these terms and Section 9.5.5 for more discussion). For the example presented in Figure 9-5, the driving resistance from the unsuitable clay layer would be reduced by the sensitivity of the clay. Therefore,  $R_{s2}$  would be  $R_{s2} / 2$  for a clay with a sensitivity of 2. The soil resistance to driving to depth D would then be as follows

$$SRD = R_{s1} + R_{s2}/2 + R_{s3} + R_t$$

This example problem considers only the driving resistance at the final pile penetration depth. In cases where piles are driven through hard or dense layers above the estimated pile penetration depth, the soil resistance to penetrate these layers should also be calculated. Additional information on the calculation of time dependent soil strength changes is provided in Section 9.9 of this chapter.

The concepts discussed above are illustrated numerically in Example 9-1:

**Example 9-1:** Find the ultimate capacity and driving capacity for the pile from the data listed in the profile. The hydraulic specialist determined that the sand layer is susceptible to scour. The geotechnical specialist determined that the soft clay layer is unsuitable for providing resistance.

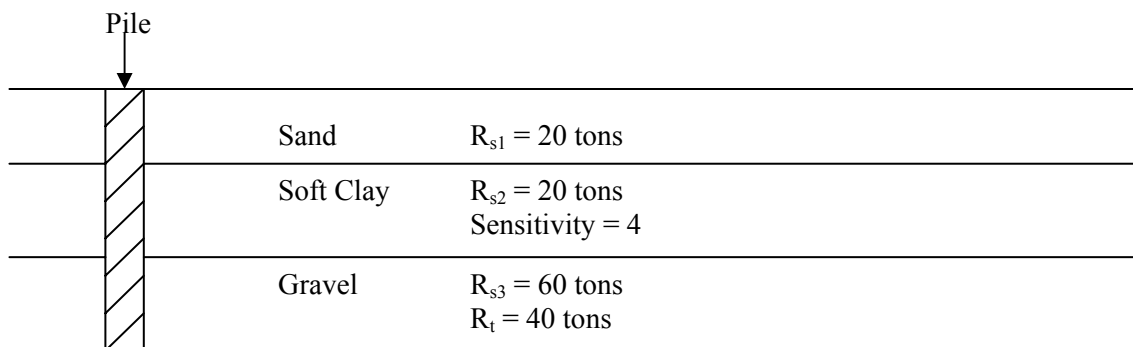

**Solution:**

$$\begin{aligned}\text{Ultimate capacity} &= R_{s3} + R_t \\ &= 60 \text{ tons} + 40 \text{ tons} = 100 \text{ tons}\end{aligned}$$

$$\begin{aligned}\text{Driving capacity} &= R_{s1} + (R_{s2}/\text{Sensitivity}) + R_{s3} + R_t \\ &= 20 \text{ tons} + \frac{20 \text{ tons}}{4} + 60 \text{ tons} + 40 \text{ tons} = 125 \text{ tons}\end{aligned}$$

## 9.5 DESIGN OF SINGLE PILES

Numerous static analysis methods are available for calculating the ultimate capacity of a single pile. The following sections of this chapter will present recommended analysis methods for piles in cohesionless, cohesive, and layered soil profiles. For additional methods based on N-values, and cone penetration test results the reader is referred to FHWA (2006a). Regardless of the method used to evaluate the static capacity of a pile, it must be understood that the factor of safety is not based on the method of analysis but on the construction control as discussed in Section 9.4. Furthermore, the pile length determined from a static analysis is just an *estimate* prior to going into the field.

### 9.5.1 Ultimate Geotechnical Capacity of Single Piles in Cohesionless Soils

The geotechnical ultimate capacity of a single pile in a cohesionless soil is the sum of shaft and toe resistances ( $Q_u = R_s + R_t$ ). The calculation assumes that the shaft resistance and toe bearing resistance can be determined separately and that these two factors do not affect each other. The Nordlund method is recommended herein for computation of ultimate capacity of single piles in cohesionless soils.

#### 9.5.1.1 Nordlund Method

The Nordlund method (1963) is based on field observations and considers pile taper and soil displacement in calculating the shaft resistance. The method also accounts for the differences in soil-pile coefficient of friction for different pile materials. The method is based on the results of several load test programs in cohesionless soils. Several pile types were used in these test programs including timber, H, closed end pipe, Monotubes and Raymond step-taper piles. These piles, which were used to develop the method's design curves, had pile widths generally in the range of 10 to 20 inches (250 to 500 mm). The Nordlund Method tends to overpredict pile



capacity for piles with widths larger than 24 inches (600 mm) and all sizes of open-ended pipe piles.

According to the Nordlund method, the geotechnical ultimate capacity,  $Q_u$ , of a pile in cohesionless soil is the sum of the shaft resistance,  $R_s$  and the toe resistance,  $R_t$ . Nordlund suggests the shaft resistance is a function of the following variables:

1. The friction angle of the soil.
2. The friction angle on the sliding surface between pile material and soil, i.e., the interface friction angle
3. The taper of the pile.
4. The effective unit weight of the soil.
5. The pile length.
6. The minimum pile perimeter.
7. The volume of soil displaced.

The Nordlund equation for computing the geotechnical ultimate capacity of a pile is as follows (see Figure 9-6 for illustration of variables):

$$Q_u = \sum_{d=0}^{d=D} K_\delta C_F p_d \frac{\sin(\delta + \omega)}{\cos \omega} C_d \Delta d + \alpha_t N'_q A_t p_t \quad 9-4$$

- where:
- $d$  = depth.
  - $D$  = embedded length of the pile.
  - $K_\delta$  = coefficient of lateral earth pressure at depth  $d$ .
  - $C_F$  = correction factor for  $K_\delta$  when  $\delta \neq \phi$ .
  - $p_d$  = effective overburden pressure at the center of depth increment  $\Delta d$ .
  - $\delta$  = interface friction angle between pile and soil.
  - $\omega$  = angle of pile taper from vertical.
  - $\phi$  = soil friction angle.
  - $C_d$  = pile perimeter at depth  $d$ .
  - $\Delta d$  = length of pile segment.
  - $\alpha_t$  = dimensionless factor dependent on pile depth-width relationship.
  - $N'_q$  = bearing capacity factor.
  - $A_t$  = pile toe area.
  - $p_t$  = effective overburden pressure at the pile toe.

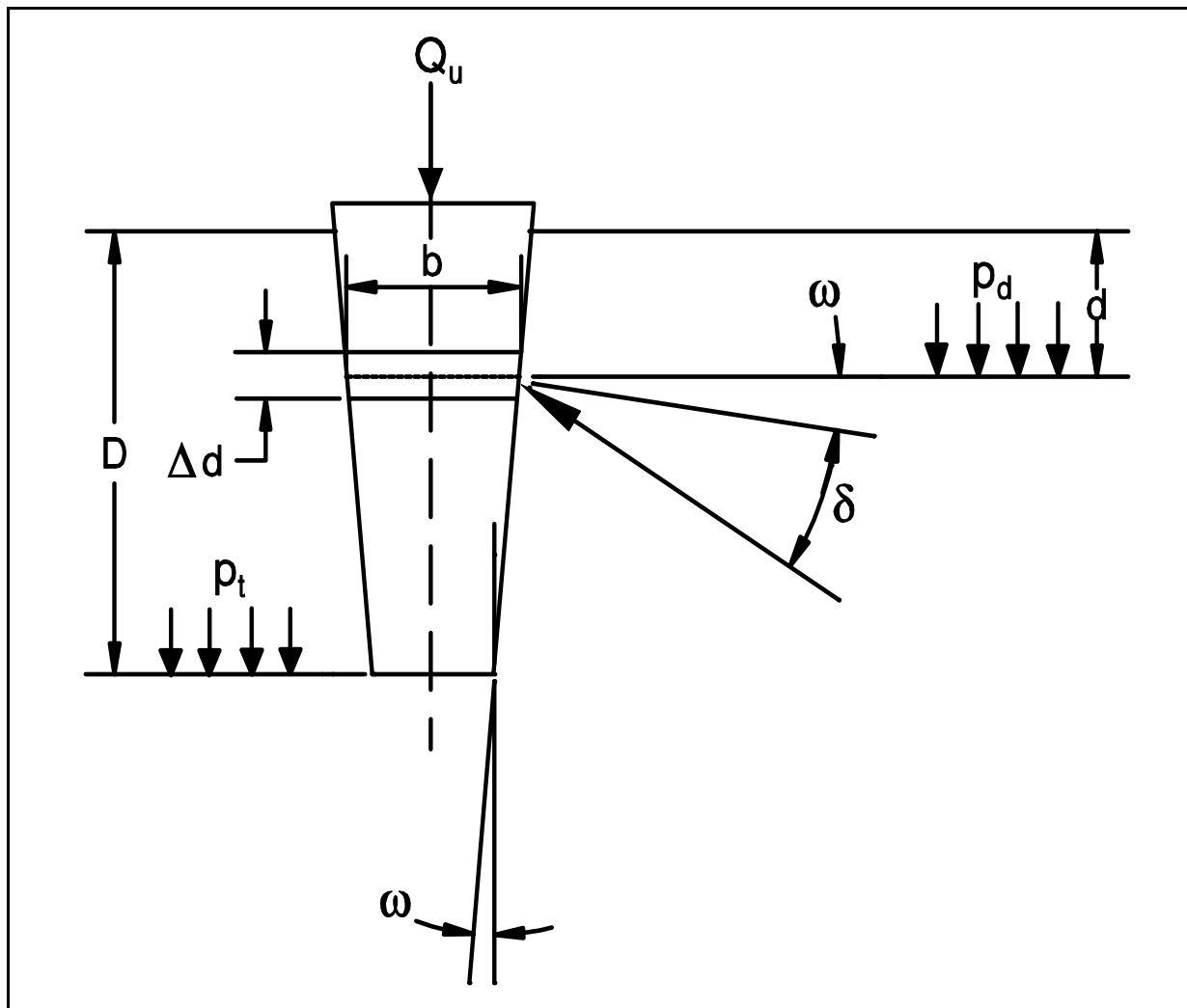

**Figure 9-6. Nordlund's general equation for ultimate pile capacity (after Nordlund, 1979).**

For a pile of uniform cross section ( $\omega=0$ ) and embedded length  $D$ , driven in soil layers of the same effective unit weight and friction angle, the Nordlund equation becomes:

$$Q_u = K_\delta C_F p_d \sin \delta C_d D + \alpha_t N'_q A_t p_t \quad 9-5$$

The soil friction angle  $\phi$  influences most of the calculations in the Nordlund method. In the absence of laboratory test data,  $\phi$  can be estimated from corrected SPT  $N_{160}$  values. Therefore, Equation 3-3 in Chapter 3 should be used for correcting field  $N$  values. The corrected SPT  $N_{160}$  values may then be used in Table 8-1 of Chapter 8 to estimate the soil friction angle,  $\phi$ .

Nordlund (1979) updated the method but did not place a limiting value on the shaft resistance. However, Nordlund recommended that the effective overburden pressure at the pile toe,  $p_t$ , used for computing the pile toe resistance be limited to 3 ksf (150 kPa).

### **STEP BY STEP PROCEDURE FOR USING NORDLUND METHOD**

Steps 1 through 6 are for computing the shaft resistance and steps 7 through 9 are for computing the pile toe resistance.

**STEP 1** Delineate the soil profile into layers and determine the  $\phi$  angle for each layer.

- a. Construct  $p_o$  diagram using procedure described in Chapter 2.
- b. Using Figure 3-24, correct SPT field  $N$  values for overburden pressure and obtain corrected SPT  $N_{160}$  values. Delineate soil profile into layers based on corrected SPT  $N_{160}$  values.
- c. Determine  $\phi$  angle for each layer from laboratory or in-situ test data.
- d. In the absence of laboratory or in-situ test data, determine the average corrected SPT  $N_{160}$  value,  $\bar{N}_1$ , for each soil layer and estimate  $\phi$  angle from Table 8-1 in Chapter 8.

**STEP 2** Determine  $\delta$ , the interface friction angle between the pile and soil based on displaced soil volume,  $V$ , and the soil friction angle,  $\phi$ .

- a. Compute volume of soil displaced per unit length of pile,  $V$ .
- b. Enter Figure 9-7 with  $V$  and determine  $\delta/\phi$  ratio for pile type under consideration. Note that  $\delta/\phi$  may be greater than 1.0 for taper piles to account for the development of passive resistance along the length of the pile due to pile taper.
- c. Calculate  $\delta$  from  $\delta/\phi$  ratio.

**STEP 3** Determine the coefficient of lateral earth pressure,  $K_\delta$ , for each  $\phi$  angle.

- a. Determine  $K_\delta$  for  $\phi$  angle based on displaced volume,  $V$ , and pile taper angle,  $\omega$ , by using either Figure 9-8, 9-9, 9-10, or 9-11 and the appropriate procedure described in Step 3b, 3c, 3d, or 3e.
- b. If the displaced volume is 0.1, 1.0 or 10.0 ft<sup>3</sup>/ft, which corresponds to one of the curves provided in Figures 9-8 through 9-11, and the  $\phi$  angle is one of those provided,  $K_\delta$  can be determined directly from the appropriate figure.
- c. If the displaced volume is 0.1, 1.0 or 10.0 ft<sup>3</sup>/ft, which corresponds to one of the curves provided in Figures 9-8 through 9-11, but the  $\phi$  angle is other than those provided, use linear interpolation to determine  $K_\delta$  for the required  $\phi$  angle. Tables 9-6a and 9-6b also provide interpolated  $K_\delta$  values at selected displaced volumes versus  $\phi$  angle for uniform piles ( $\omega = 0$ ).
- d. If the displaced volume is other than 0.1, 1.0 or 10.0 ft<sup>3</sup>/ft, which corresponds to one of the curves provided in Figures 9-8 through 9-11, and the  $\phi$  angle corresponds to one of those provided, use log linear interpolation to determine  $K_\delta$  for the required displaced volume. Tables 9-6a and 9-6b also provide interpolated  $K_\delta$  values at selected displaced volumes versus  $\phi$  angle for uniform piles ( $\omega = 0$ ).
- e. If the displaced volume is other than 0.1, 1.0 or 10.0 ft<sup>3</sup>/ft, which correspond to one of the curves provided in Figures 9-8 through 9-11, and the  $\phi$  angle is other than one of those provided, first use linear interpolation to determine  $K_\delta$  for the required  $\phi$  angle at the displaced volume curves provided for 0.1, 1.0 or 10.0 ft<sup>3</sup>/ft. Then use log linear interpolation to determine  $K_\delta$  for the required displaced volume. Tables 9-6a and 9-6b also provide interpolated  $K_\delta$  values at selected displaced volumes versus  $\phi$  angle for uniform piles ( $\omega = 0$ ).

**STEP 4** Determine the correction factor,  $C_F$ , to be applied to  $K_\delta$  if  $\delta \neq \phi$ .

Use Figure 9-12 to determine the correction factor for each  $K_\delta$ . Enter figure with  $\phi$  angle and  $\delta/\phi$  value to determine  $C_F$ .

**STEP 5** Compute the average effective overburden pressure at the midpoint of each soil layer,  $p_d$  (ksf).

**Note:** A limiting value is not applied to  $p_d$ .

**STEP 6** Compute the shaft resistance in each soil layer. Sum the shaft resistance from each soil layer to obtain the ultimate shaft resistance,  $R_s$  (kips). For a pile of uniform cross-section embedded in a uniform soil profile

$$R_s = K_\delta C_F p_d \sin \delta C_d D \quad 9-6$$

For H-piles in cohesionless soils, the "box" area should generally be used for shaft resistance calculations, i.e., the pile perimeter  $C_d$  should be considered as two times flange width plus two times the section height. Additional discussion on the behavior of open pile sections is presented in Section 9.5.4.

**STEP 7** Determine the  $\alpha_t$  coefficient and the bearing capacity factor,  $N'_q$ , from the  $\phi$  angle near the pile toe.

- a. Enter Figure 9-13(a) with  $\phi$  angle near pile toe to determine  $\alpha_t$  coefficient based on pile length to diameter ratio.
- b. Enter Figure 9-13(b) with  $\phi$  angle near pile toe to determine,  $N'_q$ .
- c. If  $\phi$  angle is estimated from SPT data, compute the average corrected SPT  $N_{160}$  value over the zone from the pile toe to 3 diameters below the pile toe.

**STEP 8** Compute the effective overburden pressure at the pile toe,  $p_t$  (ksf).

**Note:** The limiting value of  $p_t$  is 3 ksf (150 kPa).

**STEP 9** a. Compute the ultimate toe resistance,  $R_t$  (kips).

$$R_t = \alpha_t N'_q A_t p_t \quad 9-7a$$

- b. Compute the maximum ultimate toe resistance,  $R_t$  (max)

$$R_t (\text{max}) = q_L A_t \quad 9-7b$$

$q_L$  value is obtained as follows:

1. Enter Figure 9-14 with  $\phi$  angle near pile toe determined from laboratory or in-situ test data.
  2. Enter Figure 9-14 with  $\phi$  angle near the pile toe estimated from Table 8-1 in Chapter 8 and the average corrected SPT N1 near toe as described in Step 7.
- c. Use lesser of the two  $R_t$  values obtained from Equations 9-7a and 9-7b.

For steel H and unfilled open end pipe piles, use only steel cross section area at pile toe unless there is reasonable assurance and previous experience that a soil plug will form at the pile toe. The assumption of a soil plug would allow the use of a box area at H pile toe and total pipe cross section area for open end pipe pile. Additional discussion on the behavior of open pile sections is presented in Section 9.5.4.

- STEP 10** Compute the ultimate geotechnical pile capacity,  $Q_u$  (kips).

$$Q_u = R_s + R_t$$

- STEP 11** Compute the allowable geotechnical soil resistance,  $Q_a$  (kips).

$$Q_a = \frac{Q_u}{\text{Factor of Safety}}$$

The factor of safety used in the calculation should be based upon the construction control method to be specified. Recommended factors of safety based on construction control method are listed in Table 9-5.

The concepts discussed above are illustrated numerically in Example 9-2.

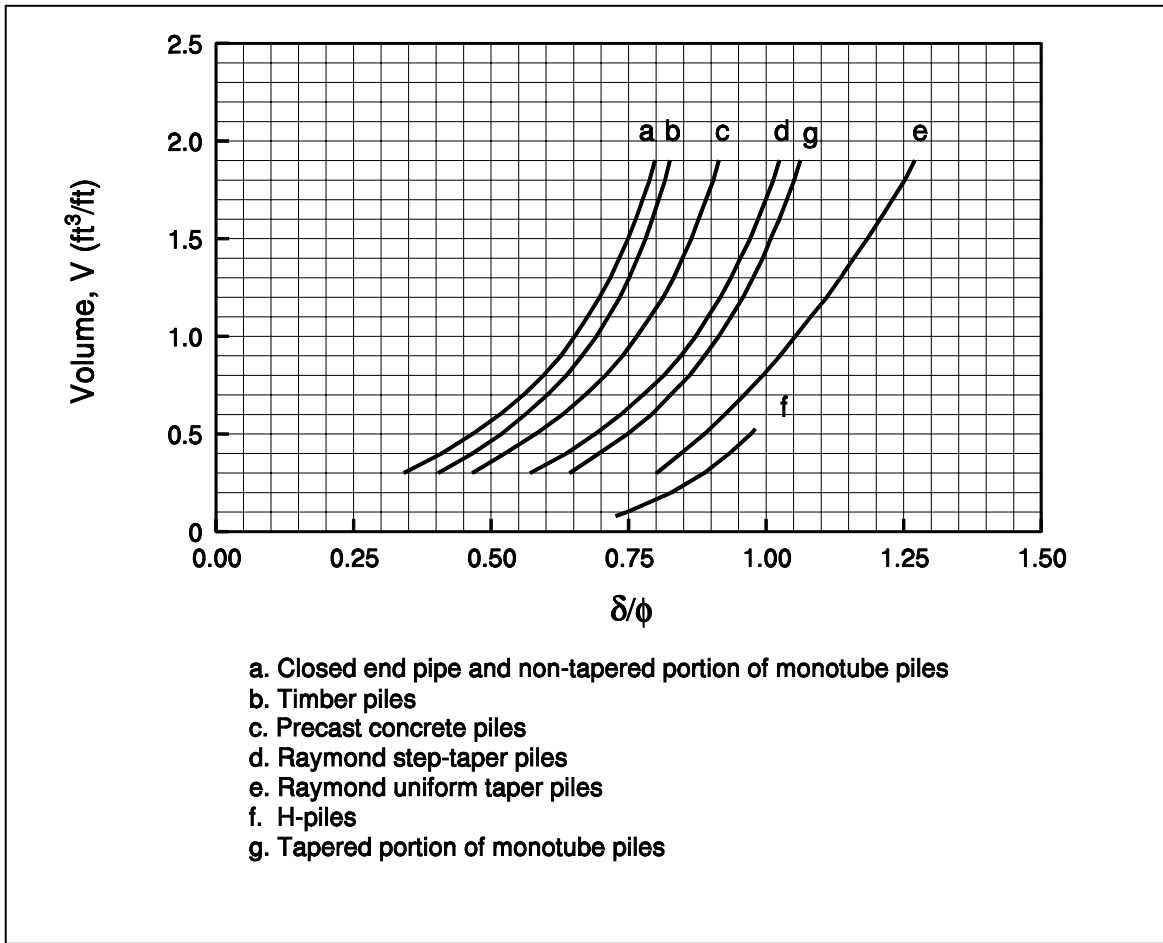

**Figure 9-7. Relationship of  $\delta/\phi$  and pile soil displacement,  $V$ , for various types of piles (after Nordlund, 1963).**

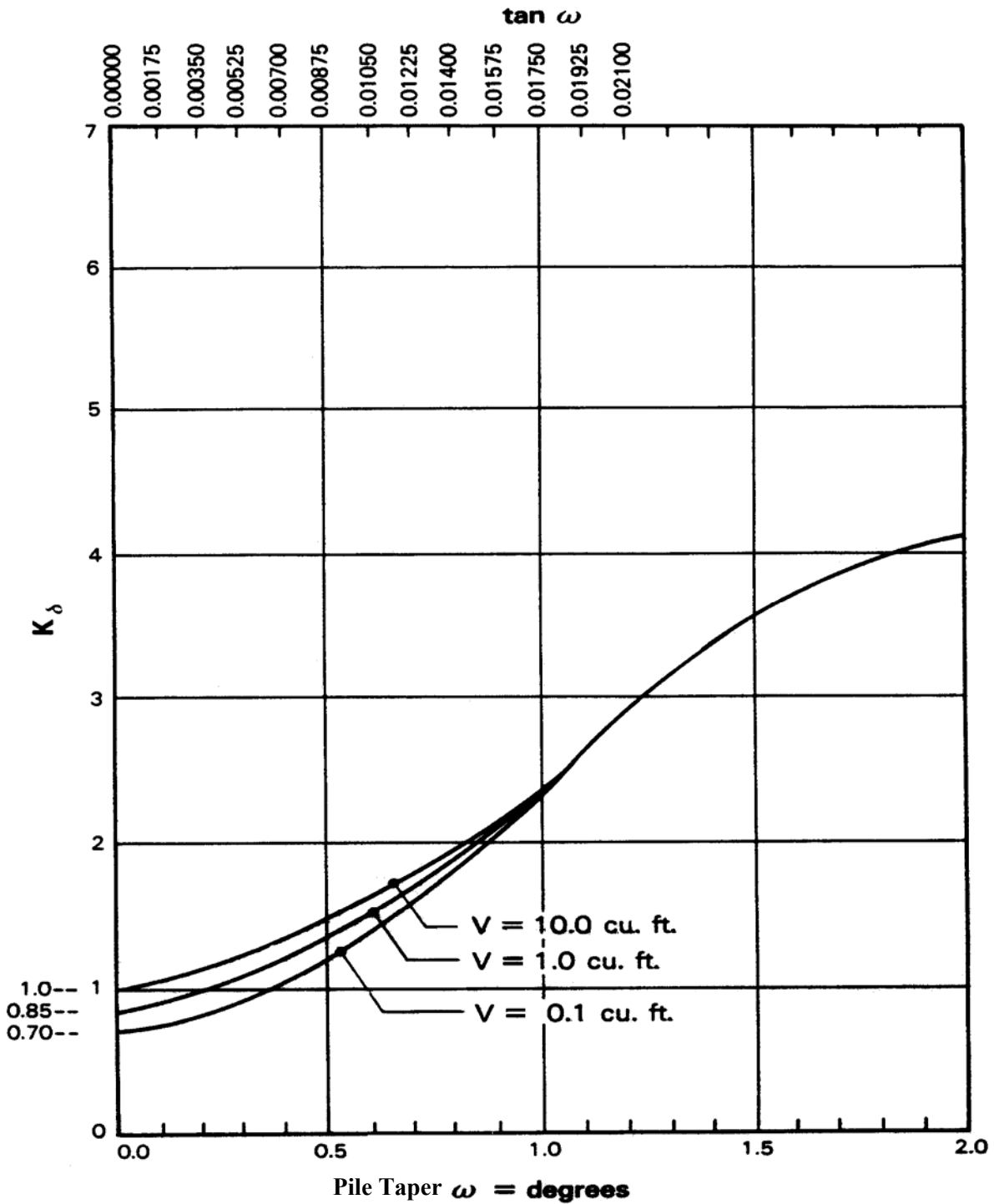

Figure 9-8. Design curves for evaluating  $K_\delta$  for piles when  $\phi = 25^\circ$  (after Nordlund, 1963).



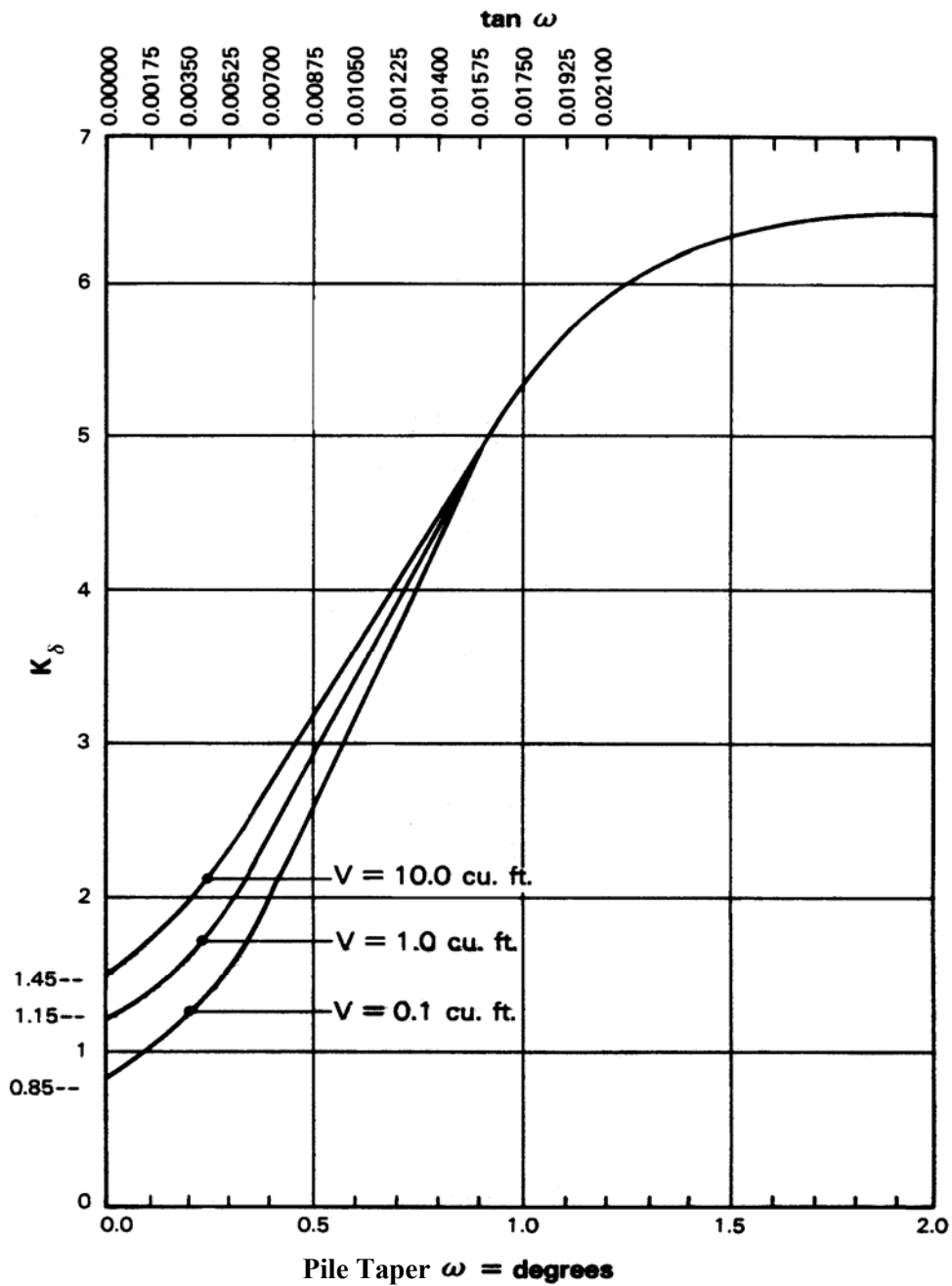

Figure 9-9. Design curves for evaluating  $K_\delta$  for piles when  $\phi = 30^\circ$  (after Nordlund, 1963).

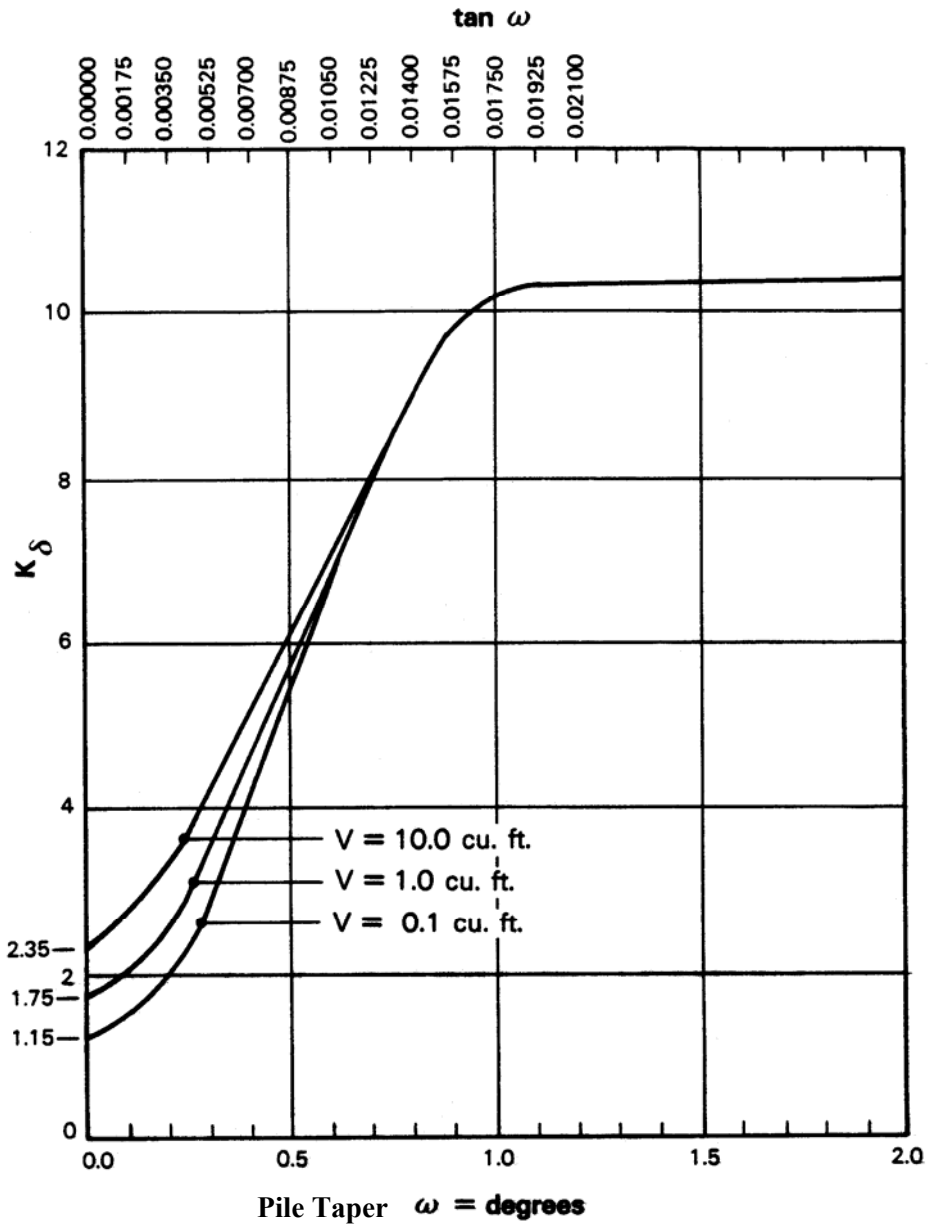

Figure 9-10. Design curves for evaluating  $K_{\delta}$  for piles when  $\phi = 35^{\circ}$  (after Nordlund, 1963).

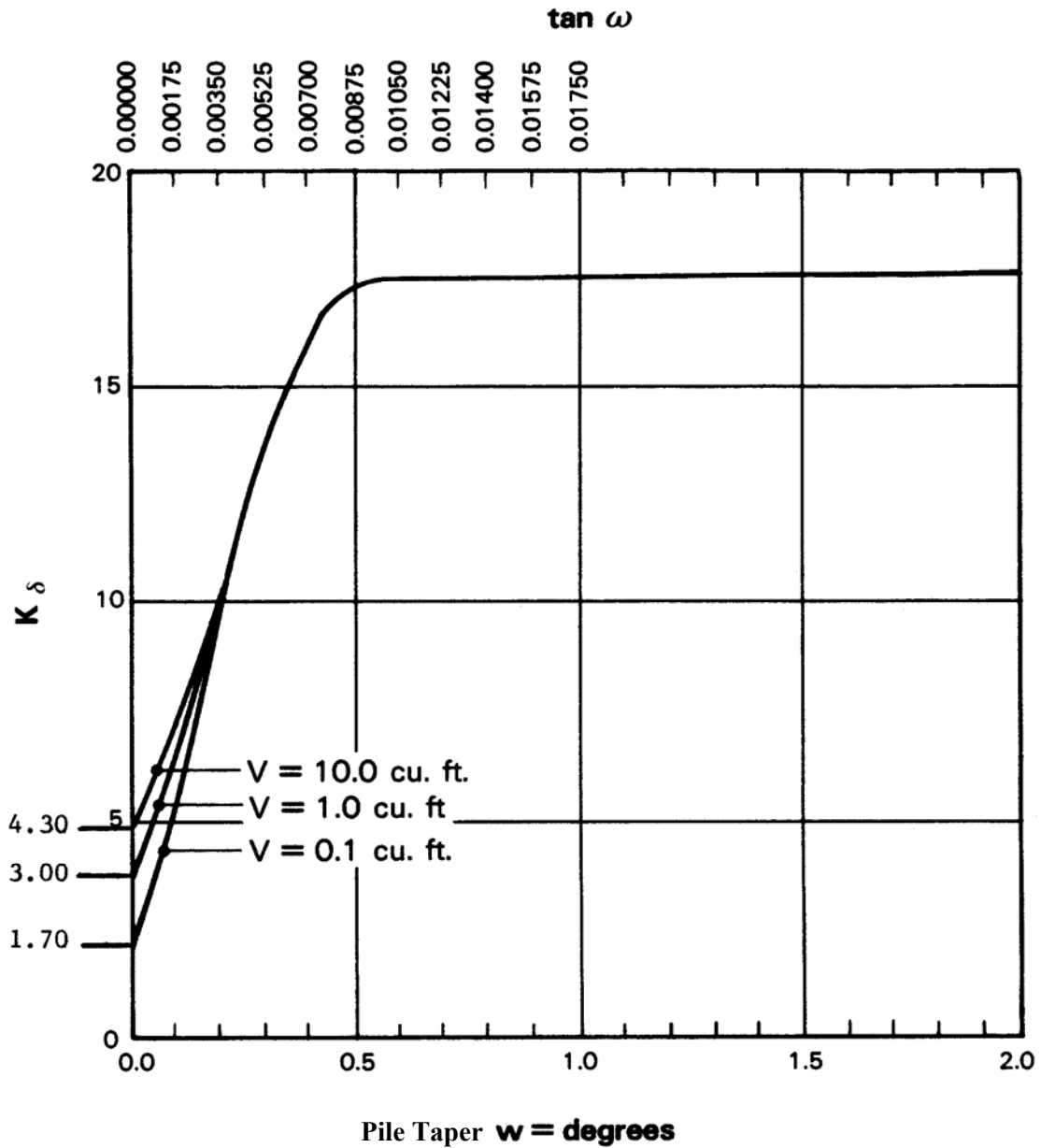

Figure 9-11. Design curves for evaluating  $K_{\delta}$  for piles when  $\phi = 40^{\circ}$  (after Nordlund, 1963).

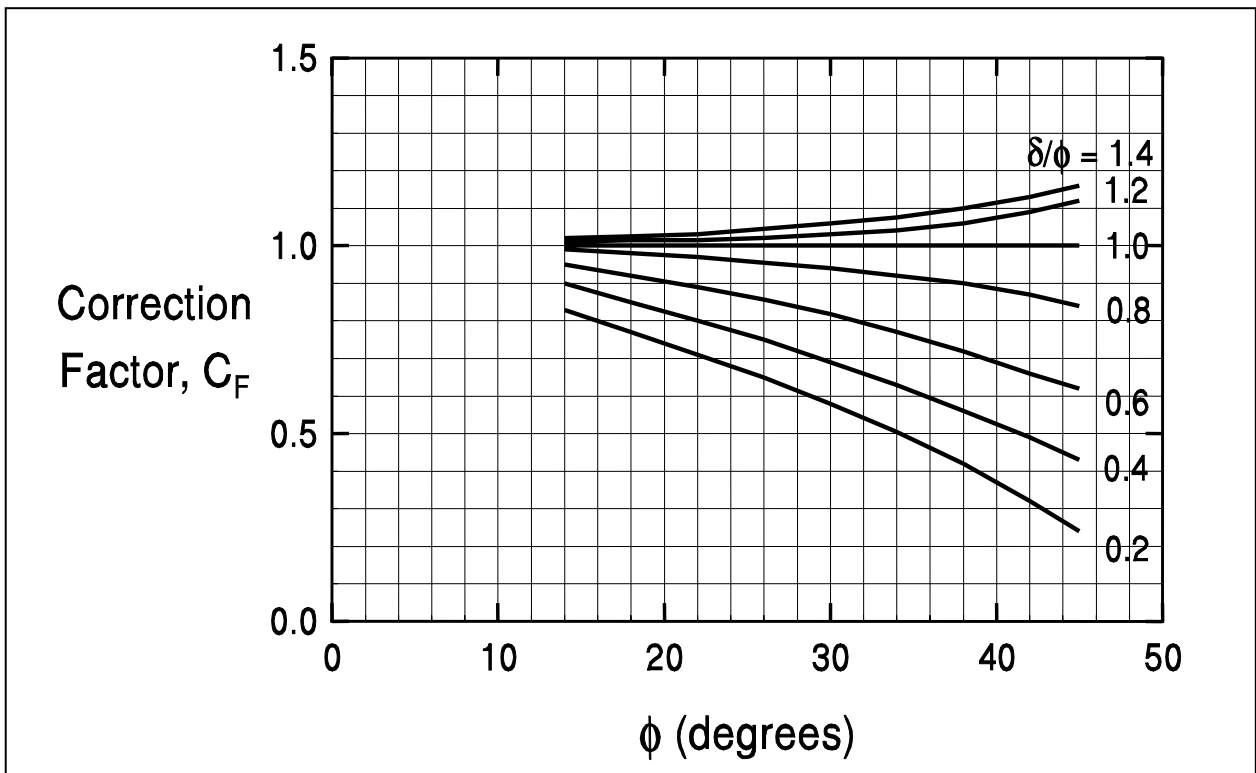

Figure 9-12. Correction factor,  $C_F$  for  $K_\delta$  when  $\delta \neq \phi$  (after Nordlund, 1963).

**Table 9-6(a)**

**Design table for evaluating  $K_{\delta}$  for piles when  $\omega = 0^{\circ}$  and  $V = 0.10$  to  $1.00$  ft<sup>3</sup>/ft (FHWA, 2006a)**

$\phi$	Displaced Volume -V (ft <sup>3</sup> /ft)									
	0.10	0.20	0.30	0.40	0.50	0.60	0.70	0.80	0.90	1.00
25	0.70	0.75	0.77	0.79	0.80	0.82	0.83	0.84	0.84	0.85
26	0.73	0.78	0.82	0.84	0.86	0.87	0.88	0.89	0.90	0.91
27	0.76	0.82	0.86	0.89	0.91	0.92	0.94	0.95	0.96	0.97
28	0.79	0.86	0.90	0.93	0.96	0.98	0.99	1.01	1.02	1.03
29	0.82	0.90	0.95	0.98	1.01	1.03	1.05	1.06	1.08	1.09
30	0.85	0.94	0.99	1.03	1.06	1.08	1.10	1.12	1.14	1.15
31	0.91	1.02	1.08	1.13	1.16	1.19	1.21	1.24	1.25	1.27
32	0.97	1.10	1.17	1.22	1.26	1.30	1.32	1.35	1.37	1.39
33	1.03	1.17	1.26	1.32	1.37	1.40	1.44	1.46	1.49	1.51
34	1.09	1.25	1.35	1.42	1.47	1.51	1.55	1.58	1.61	1.63
35	1.15	1.33	1.44	1.51	1.57	1.62	1.66	1.69	1.72	1.75
36	1.26	1.48	1.61	1.71	1.78	1.84	1.89	1.93	1.97	2.00
37	1.37	1.63	1.79	1.90	1.99	2.05	2.11	2.16	2.21	2.25
38	1.48	1.79	1.97	2.09	2.19	2.27	2.34	2.40	2.45	2.50
39	1.59	1.94	2.14	2.29	2.40	2.49	2.57	2.64	2.70	2.75
40	1.70	2.09	2.32	2.48	2.61	2.71	2.80	2.87	2.94	3.0

**Table 9-6(b)**

**Design table for evaluating  $K_{\delta}$  for piles when  $\omega = 0^\circ$  and  $V = 1.0$  to  $10.0 \text{ ft}^3/\text{ft}$  (FHWA, 2006a)**

$\phi$	Displaced Volume –V (ft <sup>3</sup> /ft)									
	1.0	2.0	.3.0	4.0	5.0	6.0	7.0	8.0	9.0	10.0
25	0.85	0.90	0.92	0.94	0.95	0.97	0.98	0.99	0.99	1.00
26	0.91	0.96	1.00	1.02	1.04	1.05	1.06	1.07	1.08	1.09
27	0.97	1.03	1.07	1.10	1.12	1.13	1.15	1.16	1.17	1.18
28	1.03	1.10	1.14	1.17	1.20	1.22	1.23	1.25	1.26	1.27
29	1.09	1.17	1.22	1.25	1.28	1.30	1.32	1.33	1.35	1.36
30	1.15	1.24	1.29	1.33	1.36	1.38	1.40	1.42	1.44	1.45
31	1.27	1.38	1.44	1.49	1.52	1.55	1.57	1.60	1.61	1.63
32	1.39	1.52	1.59	1.64	1.68	1.72	1.74	1.77	1.79	1.81
33	1.51	1.65	1.74	1.80	1.85	1.88	1.92	1.94	1.97	1.99
34	1.63	1.79	1.89	1.96	2.01	2.05	2.09	2.12	2.15	2.17
35	1.75	1.93	2.04	2.11	2.17	2.22	2.26	2.29	2.32	2.35
36	2.00	2.22	2.35	2.45	2.52	2.58	2.63	2.67	2.71	2.74
37	2.25	2.51	2.67	2.78	2.87	2.93	2.99	3.04	3.09	3.13
38	2.50	2.81	2.99	3.11	3.21	3.29	3.36	3.42	3.47	3.52
39	2.75	3.10	3.30	3.45	3.56	3.65	3.73	3.80	3.86	3.91
40	3.00	3.39	3.62	3.78	3.91	4.01	4.10	4.17	4.24	4.30

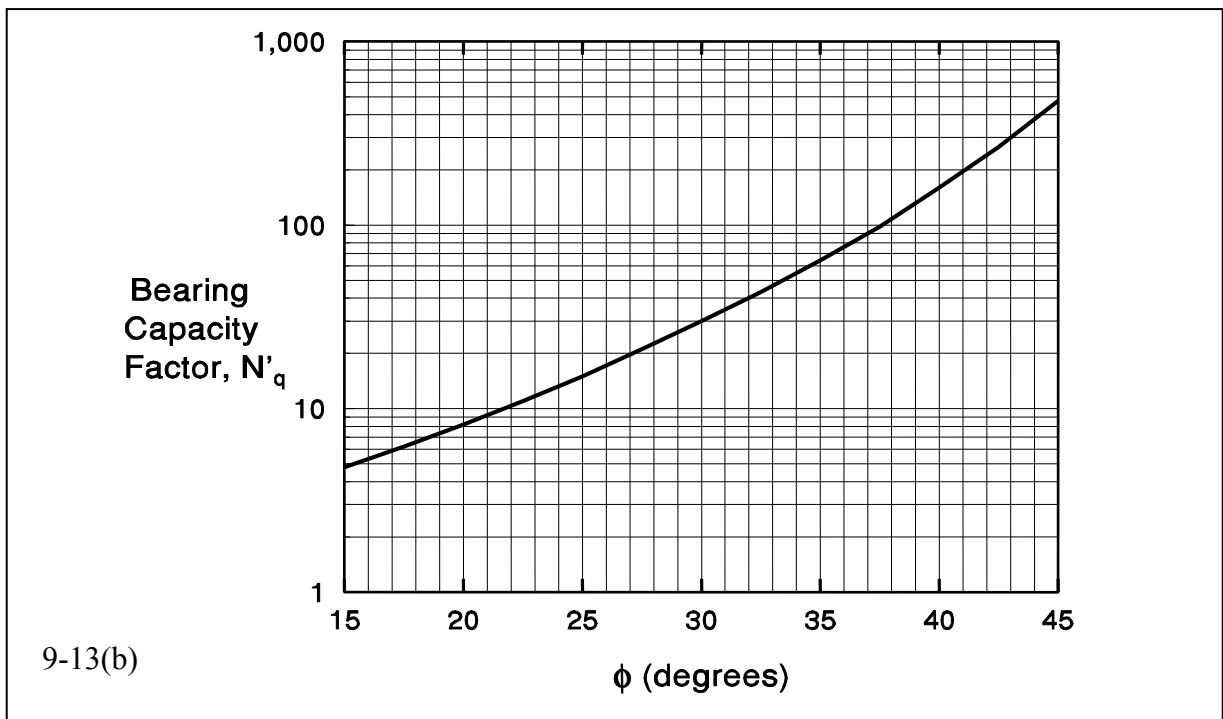
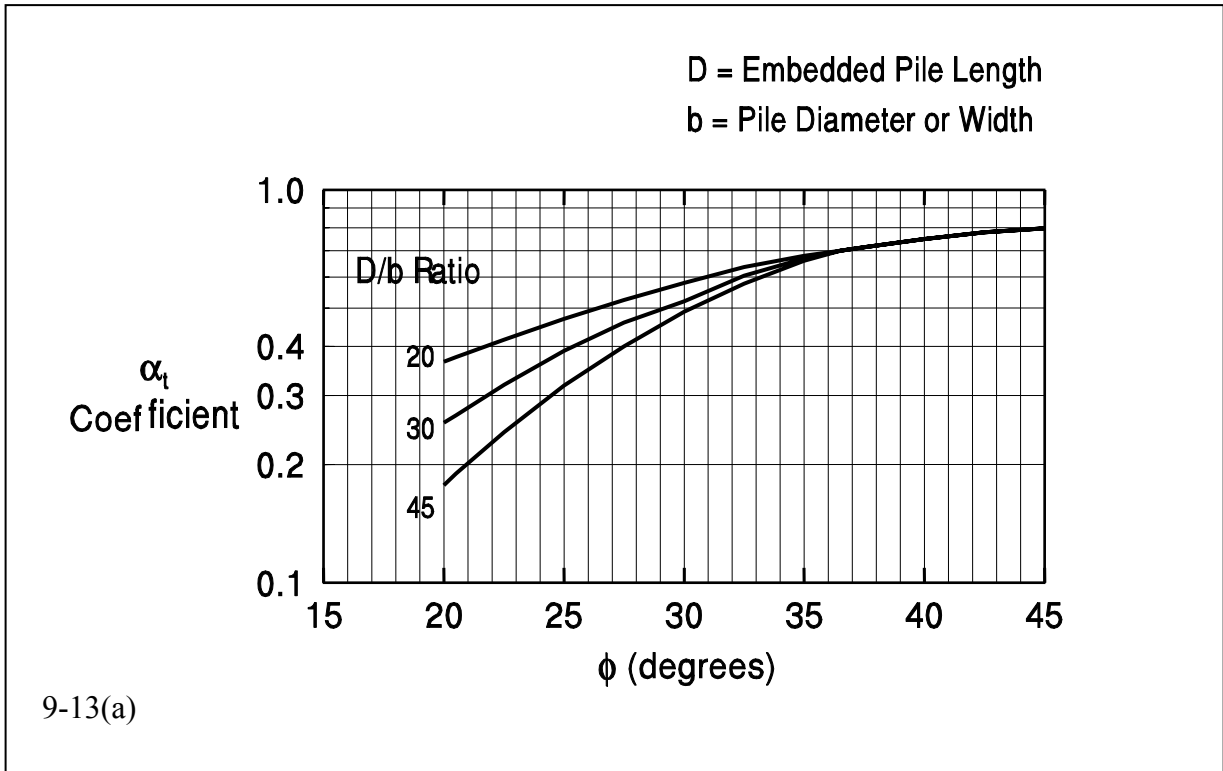

**Figure 9-13. Chart for estimating  $\alpha_t$  coefficient and bearing capacity factor  $N'_q$  (FHWA, 2006a).**

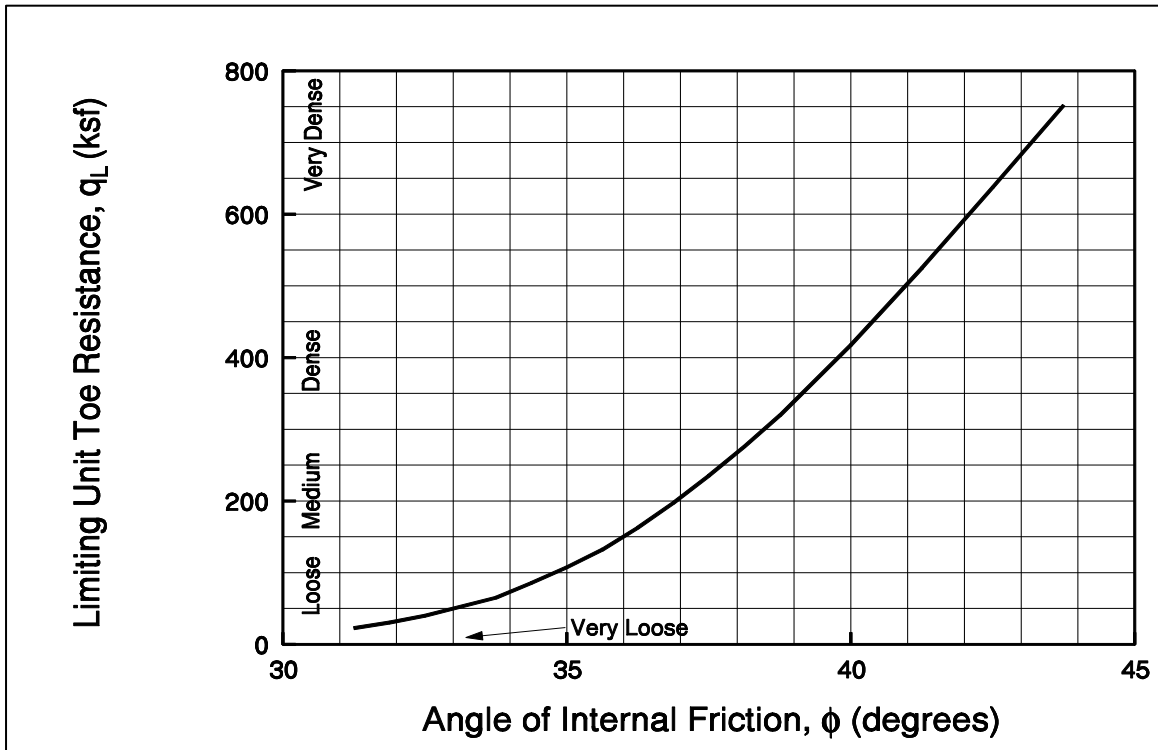

**Figure 9-14. Relationship between maximum unit pile toe resistance and friction angle for cohesionless soils (after Meyerhof, 1976).**



**Example 9-2:** Determine the ultimate geotechnical pile capacity,  $Q_u$ , for the 1 sq ft precast concrete pile

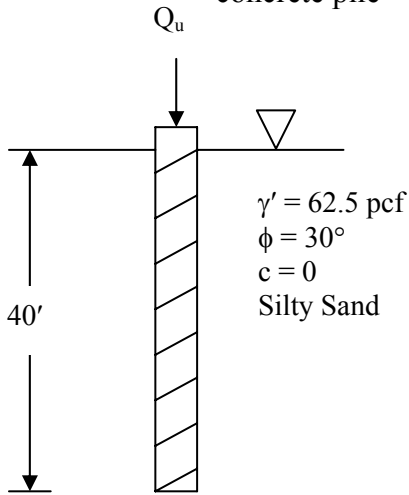

Since  $\omega = 0$ , use Equation 9-5

$$Q_u = K_\delta C_F p_d \sin \delta C_d D + A_t \alpha_t p_t N'_q$$

where the following terms are known from the problem

$$A_t = 1 \text{ sq.ft}$$

$$p_t = 40 \gamma' = 2,500 \text{ psf}$$

$$p_d = 20 \gamma' = 1,250 \text{ psf}$$

$$\omega = 0^\circ, D = 40 \text{ ft}, C_d = 4 \text{ ft}$$

**Solution:**

**Find Shaft Resistance,  $R_s$ :**

Use Figures 9-7, 9-9, and 9-12 with  $\phi = 30^\circ$

From Figure 9-7 – For  $V = 1 \text{ ft}^3/\text{ft}$ , and curve “c” for precast concrete piles;

$$\frac{\delta}{\phi} = 0.76, \quad \text{Since } \phi = 30^\circ, \quad \delta = 22.8^\circ$$

From Figure 9-9 – For  $\omega = 0$ ,  $V = 1 \text{ ft}^3/\text{ft}$ ;  $K_\delta = 1.15$

From Figure 9-12 – For  $\frac{\delta}{\phi} = 0.76$ ;  $C_F = 0.9$

$$R_s = K_\delta C_F p_d \sin \delta C_d D$$

Equation 9-6

$$R_s = (1.15)(0.9)(1,250 \text{ psf})(\sin 22.8^\circ)(4 \text{ ft})(40 \text{ ft}) = 80,216 \text{ lbs}$$

$$R_s = 40.1 \text{ tons}$$

**Find Toe Resistance,  $R_t$ :**

Use Figure 9-13(b) to find  $N'_q$  and  $\alpha_t$  for  $\phi = 30^\circ$

$$N'_q = 30; \alpha_t = 0.5 \text{ (for } \frac{D}{B} = 40)$$

$$R_t = A_t \alpha_t p_t N'_q = (1 \text{ ft}^2)(0.5)(2,500 \text{ psf}) 30 = 37,500 \text{ lbs} = 18.75 \text{ tons}$$

Equation 9-7a

Check limiting point resistance from Figure 9-14,  $q_L \approx 10 \text{ ksf} \approx 5 \text{ tsf}$

$$R_t = q_L A_t = (5 \text{ tsf})(1 \text{ ft}^2) = 5 \text{ tons} \quad \therefore R_t = 5 \text{ tons}$$

Equation 9-7b

**Compute Ultimate Capacity,  $Q_u$ :**

$$Q_u = R_s + R_t = 40.1 + 5 = 45.1 \text{ tons}$$

## 9.5.2 Ultimate Geotechnical Capacity of Single Piles in Cohesive Soils

The ultimate geotechnical capacity of a pile in cohesive soil may also be expressed as the sum of the shaft and toe resistances or  $Q_u = R_s + R_t$ . The shaft and toe resistances can be calculated from static analysis methods using soil boring and laboratory test data in either total stress or effective stress methods. The  $\alpha$ -method is a total stress method that uses undrained soil shear strength parameters for calculating static pile capacity in cohesive soil. The  $\alpha$ -method will be presented in Section 9.5.2.1. The effective stress method, or  $\beta$ -method, uses drained soil strength parameters for capacity calculations. Since the effective stress method may be used for calculating static pile capacity in cohesive as well as cohesionless soils, this method will be presented in Section 9.5.2.2. Alternatively, in-situ CPT test results can also be used to calculate pile capacity in cohesive soils from cone sleeve friction and cone tip resistance values. CPT-based methods as well as other methods are discussed in FHWA (2006a).

The shaft resistance of piles driven into cohesive soils is frequently as much as 80 to 90% of the total capacity. Therefore, it is important that the shaft resistance of piles in cohesive soils be estimated as accurately as possible.

### 9.5.2.1 Total Stress – $\alpha$ -method

For piles in clay, a total stress analysis is often used where ultimate capacity is calculated from the undrained shear strength of the soil. This approach assumes that the shaft resistance is independent of the effective overburden pressure and that the unit shaft resistance can be expressed in terms of an empirical adhesion factor times the undrained shear strength.

#### Shaft Resistance

The unit shaft resistance,  $f_s$ , is equal to the adhesion,  $c_a$ , which is the shear stress between the pile and soil at failure. This may be expressed in equation form as:

$$f_s = c_a = \alpha c_u \quad 9-8$$

in which  $\alpha$  is an empirical factor applied to the average undrained shear strength,  $c_u$ , of undisturbed clay along the embedded length of the pile. The coefficient  $\alpha$  depends on the nature and strength of the clay, magnitude of load, pile dimension, method of pile installation, and time effects. The values of  $\alpha$  vary within wide limits and decrease rapidly with increasing shear strength.

The adhesion factor,  $\alpha$ , is a function of the soil stratigraphy and pile embedment. Three common cases are as follows:

- Case 1: Piles driven into stiff clays through overlying sands or sandy gravels
- Case 2: Piles driven into stiff clays through overlying soft clays
- Case 3: Piles driven into stiff clays without overlying different strata

Figure 9-15 presents the adhesion factor,  $\alpha$ , versus the undrained shear strength of the soil as a function of unique soil stratigraphy and pile embedment for Case 1 and Case 2. The adhesion factor from these soil stratigraphy cases should be used only for determining the adhesion in a stiff clay layer in that specific condition as follows:

- **Case 1:** The top graph in Figure 9-15 may be used to select the adhesion factor when piles are driven through a sand or sandy gravel layer and into an underlying stiff clay stratum. This case results in the highest adhesion factors as granular material is dragged into the underlying clays. The greater the pile penetration into the clay stratum, the less influence the overlying granular stratum has on the adhesion factor. Therefore, for the same undrained shear strength, the adhesion factor decreases with increased pile penetration into the clay stratum.
- **Case 2:** The bottom graph in Figure 9-15 should be used to select the adhesion factor when piles are driven through a soft clay layer overlying a stiff clay layer. In this case, the soft clay is dragged into the underlying stiff clay stratum thereby reducing the adhesion factor of the underlying stiff clay soils. The greater the pile penetration into the underlying stiff clay soils, the less the influence the overlying soft clays have on the stiff clay adhesion factor. Therefore, the stiff clay adhesion factor increases with increasing pile penetration into the stiff clay soils.

Figure 9-16 presents the adhesion factor,  $\alpha$ , versus the undrained shear strength of the soil for piles driven in stiff clays without any different overlying strata, i.e., Case 3. In stiff clays, a gap often forms between the pile and the soil along the upper portion of the pile shaft. In this case, the shallower the pile penetration into a stiff clay stratum the greater the effect the gap has on the shaft resistance that develops. Hence, the adhesion factor for a given shear strength is reduced at shallow pile penetration depths and increased at deeper pile penetration depths.

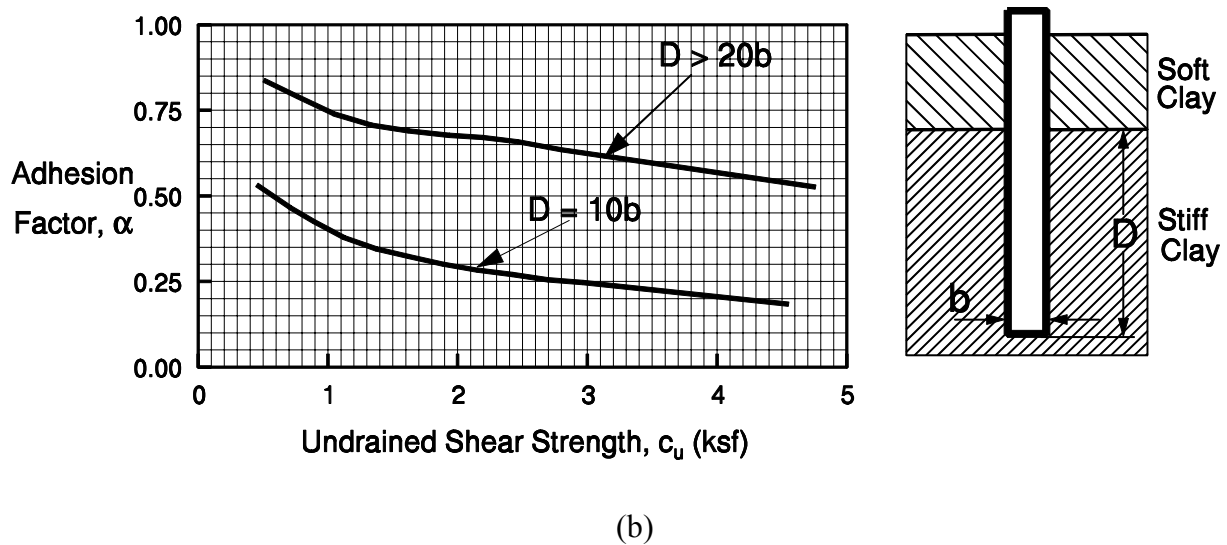
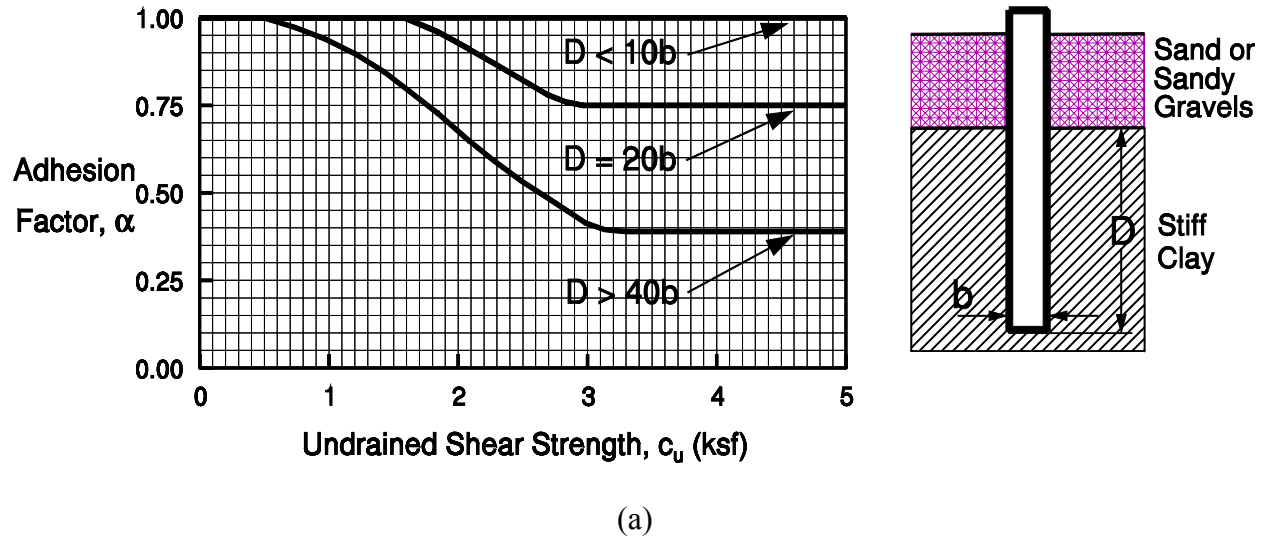

**Figure 9-15. Adhesion values for driven piles in mixed soil profiles, (a) Case 1: piles driven through overlying sands or sandy gravels, and (b) Case 2: piles driven through overlying weak clay (Tomlinson, 1980).**

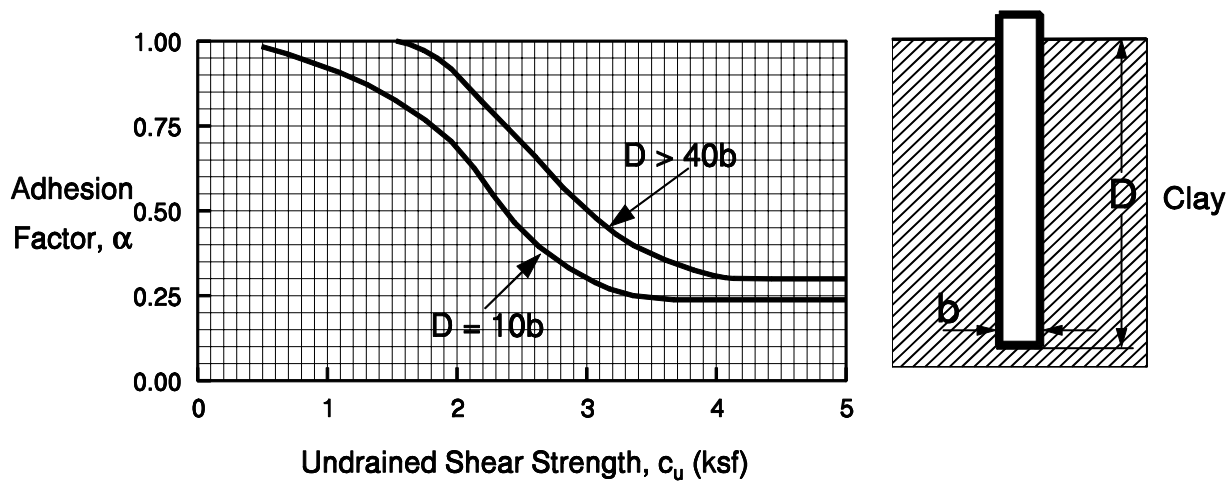

**Figure 9-16. Adhesion values for driven piles in stiff clays without different overlying strata (Case 3) (Tomlinson, 1980).**

The following should be considered by the designer while using Figures 9-15 and 9-16:

- For a soil profile consisting of clay layers of significantly different consistencies such as soft clays over stiff clays, adhesion factors should be determined for each individual clay layer.
- In clays with large shrink-swell potential, static capacity calculations should ignore the shaft resistance from the adhesion in the shrink-swell zone. During dry times, shrinkage will create a gap between the clay and the pile in this zone, therefore the shaft resistance should not be relied upon for long term support.
- In cases where either Figures 9-15b or 9-16 could be used, the inexperienced user should select and use the smaller value obtained from either figure. All users should confirm the applicability of a selected design chart in a given soil condition with local correlations between static capacity calculations and static load tests results.
- In the case of H piles in cohesive soils, the shaft resistance should not be calculated from the surface area of the pile, but rather from the sub-divided perimeter area of the four sides. The shaft resistance for H-piles in cohesive soils consists of the sum of the adhesion,  $c_a$ , times the flange surface area along the exterior of the two flanges, plus the undrained shear strength of the soil,  $c_u$ , times the section height surface area of the two remaining sides. This computation can be approximated by determining the adhesion and multiplying the

adhesion by the H-pile "box perimeter" area. Further discussion on this topic is included in Section 9.5.4.

### **Toe Resistance**

The unit toe resistance in a total stress analysis for homogeneous cohesive soil is as follows:

$$q_t = c_u N_c \quad 9-9$$

The term  $N_c$  is a dimensionless bearing capacity factor that depends on the pile diameter and the depth of embedment and  $c_u$  is the undrained shear strength of the material at and below the toe of the pile. The bearing capacity factor,  $N_c$ , is usually taken as 9 for deep foundations.

It should be remembered that the movement required to mobilize the toe resistance is several times greater than that required to mobilize the shaft resistance. At the movement required to fully mobilize the toe resistance, the shaft resistance may have decreased to a residual value. Therefore, the contribution of the toe resistance to the ultimate pile capacity in cohesive soils is sometimes ignored except in hard cohesive deposits such as glacial tills.

### **STEP BY STEP PROCEDURE FOR - " $\alpha$ -METHOD"**

**STEP 1** Delineate the soil profile into layers and determine the adhesion,  $c_a$ , from Figure 9-15 and 9-16 as appropriate. for each layer.

Enter the appropriate figure with the undrained shear strength of the soil,  $c_u$ , and determine adhesion or adhesion factor based on the ratio of the embedded pile length in clay,  $D$ , and the pile diameter,  $b$ . Use the  $D/b$  curve for the appropriate soil and embedment condition.

**STEP 2** For each soil layer, compute the unit shaft resistance,  $f_s$  in ksf (kPa).

$$f_s = c_a = \alpha c_u$$

where:  $c_a$  = adhesion and  $\alpha$  = adhesion factor.

**STEP 3** Compute the shaft resistance in each soil layer and the ultimate shaft resistance,  $R_s$ , in kips (kN), from the sum of the shaft resistance from each layer.

$$R_s = f_s A_s \quad 9-10$$

where:  $A_s$  = pile-soil surface area in  $\text{ft}^2$  ( $\text{m}^2$ ) = (pile perimeter) x (length).

**STEP 4** Compute the unit toe resistance,  $q_t$  in ksf (kPa).

$$q_t = 9 c_u$$

where:  $c_u$  = undrained shear strength of soil at the pile toe in ksf (kPa)

**STEP 5** Compute the ultimate toe resistance,  $R_t$  in kips (kN).

$$R_t = q_t A_t \quad 9-11$$

where:  $A_t$  = Area of pile toe in  $\text{ft}^2$  ( $\text{m}^2$ ).

**STEP 6** Compute the ultimate geotechnical pile capacity,  $Q_u$  in kips (kN).

$$Q_u = R_s + R_t$$

**STEP 7** Compute the allowable geotechnical soil resistance,  $Q_a$  in kips (kN).

$$Q_a = \frac{Q_u}{\text{Factor of Safety}}$$

The factor of safety in this static calculation should be based on the specified construction control method as described in Section 9.4 of this chapter. Factors of safety for various construction control methods are listed in Table 9-5.

### 9.5.2.2 Effective Stress – $\beta$ -method

Static capacity calculations in cohesionless, cohesive, and layered soils can also be performed by using an effective stress based method. Effective stress based methods were developed to model the long term drained shear strength conditions. Therefore, the effective soil friction angle,  $\phi'$ , should be used in parameter selection.

In an effective stress analysis, the unit shaft resistance is calculated from the following expression:

$$f_s = \beta p_o \quad 9-12$$

where:  $\beta$  = Bjerrum-Burland beta coefficient =  $K_s \tan \delta$ .  
 $p_o$  = average effective overburden pressure along the pile shaft, in ksf (kPa).  
 $K_s$  = earth pressure coefficient.  
 $\delta$  = interface friction angle between pile and soil.

The unit toe resistance is calculated from:

$$q_t = N_t p_t \quad 9-13$$

where:  $N_t$  = toe bearing capacity coefficient.  
 $p_t$  = effective overburden pressure at the pile toe in ksf (kPa).

Recommended ranges of  $\beta$  and  $N_t$  coefficients as a function of soil type and  $\phi'$  angle from Fellenius (1991) are presented in Table 9-7. Fellenius (1991) notes that factors affecting the  $\beta$  and  $N_t$  coefficients consist of the soil composition including the grain size distribution, angularity and mineralogical origin of the soil grains, the original soil density and density due to the pile installation technique, the soil strength, as well as other factors. Even so,  $\beta$  coefficients are generally within the ranges provided and seldom exceed 1.0.



**Table 9-7**  
**Approximate range of  $\beta$  and  $N_t$  coefficients (Fellenius, 1991)**

<b>Soil Type</b>	<b><math>\phi'</math></b>	<b><math>\beta</math></b>	<b><math>N_t</math></b>
Clay	25 – 30	0.23 - 0.40	3 - 30
Silt	28 – 34	0.27 - 0.50	20 - 40
Sand	32 – 40	0.30 - 0.60	30 - 150
Gravel	35 – 45	0.35 - 0.80	60 - 300

For sedimentary cohesionless deposits, Fellenius (1991) that states  $N_t$  ranges from about 30 to a high of 120. In very dense non-sedimentary deposits such as glacial tills,  $N_t$  can be much higher, but it can also approach the lower bound value of 30. In clays, Fellenius (1991) notes that the toe resistance calculated by using an  $N_t$  of 3 is similar to the toe resistance calculated from an analysis where undrained shear strength is used. Therefore, the use of a relatively low value of the  $N_t$  coefficient in clays is recommended unless local correlations suggest higher values are appropriate.

Graphs of the ranges in  $\beta$  and  $N_t$  coefficients versus the range in  $\phi'$  angle as suggested by Fellenius are presented in Figure 9-17 and 9-18, respectively. These graphs may be helpful in selection of  $\beta$  or  $N_t$ . The inexperienced user should select conservative  $\beta$  and  $N_t$  coefficients. As with any design method, the user should also confirm the appropriateness of a selected  $\beta$  or  $N_t$  coefficient in a given soil condition with local correlations between static capacity calculations and static load tests results.

It should be noted that the effective stress method places no limiting values on either the shaft or toe resistance.

### **STEP BY STEP PROCEDURE FOR THE EFFECTIVE STRESS METHOD**

- STEP 1** Delineate the soil profile into layers and determine  $\phi'$  angle for each layer.
- a. Construct  $p_o$  diagram by using previously described procedures in Chapter 2.
  - b. Divide soil profile throughout the pile penetration depth into layers and determine the effective overburden pressure,  $p_o$ , in ksf (kPa) at the midpoint of each layer.
  - c. Determine the  $\phi'$  angle for each soil layer from laboratory or in-situ test data.

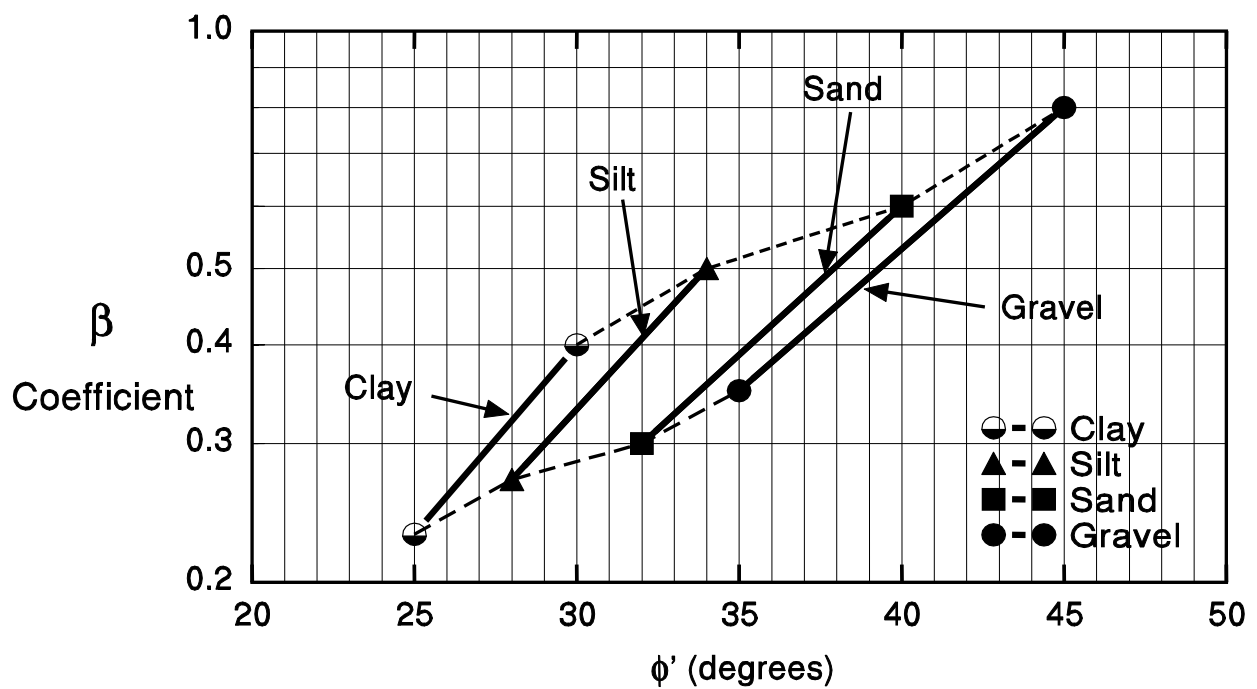

Figure 9-17. Chart for estimating  $\beta$  coefficient as a function of soil type  $\phi'$  (after Fellenius, 1991).

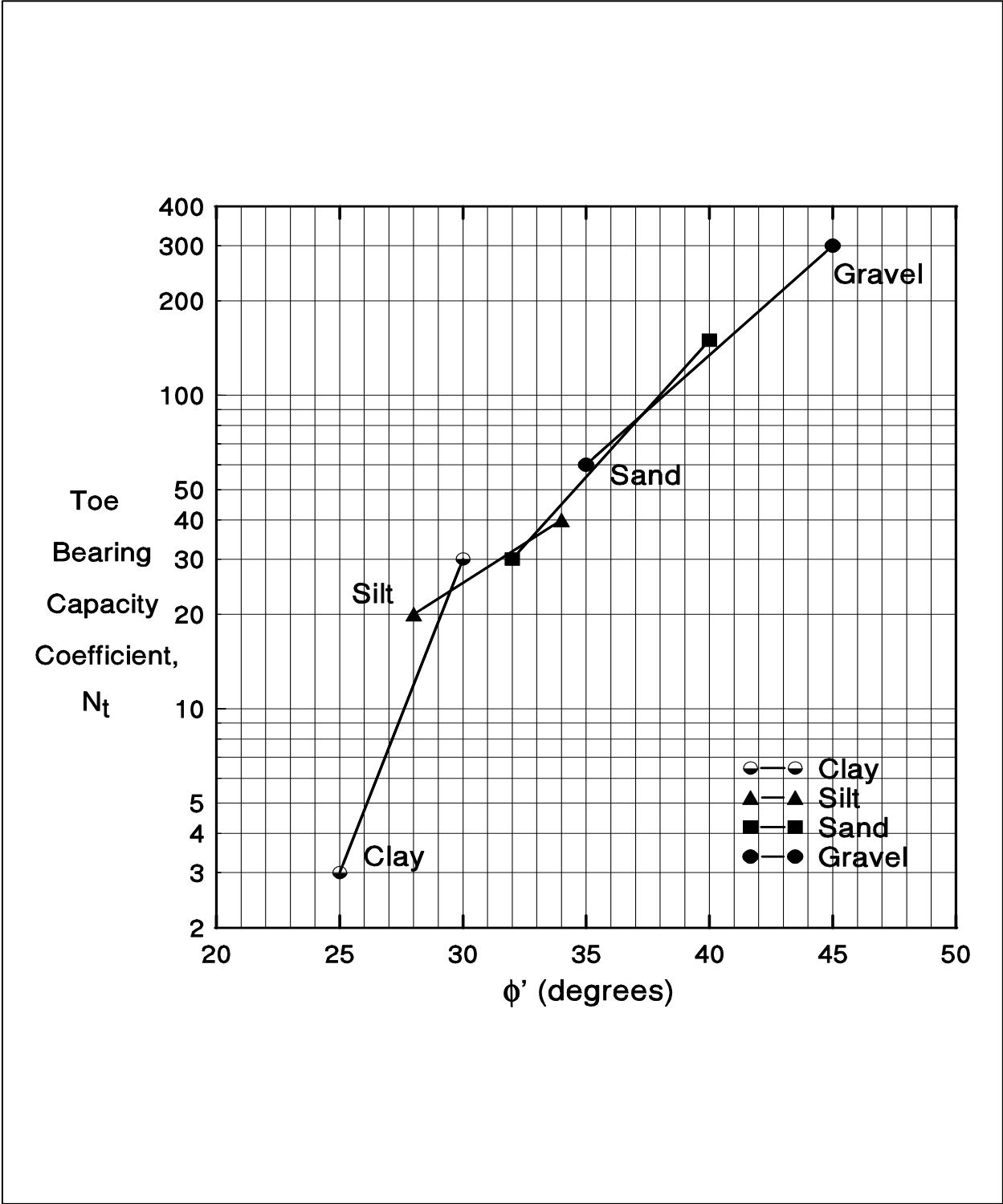

Figure 9-18. Chart for estimating  $N_t$  coefficients as a function of soil type  $\phi'$  angle (after Fellenius, 1991).

- d. In the absence of laboratory or in-situ test data for cohesionless layers, determine the average corrected SPT  $N_1$  value for each layer and estimate  $\phi'$  angle from Table 8-1 in Chapter 8.

**STEP 2** Select the  $\beta$  coefficient for each soil layer.

- a. Use local experience to select  $\beta$  coefficient for each layer.
- b. In the absence of local experience, use Table 9-7 or Figure 9-17 to estimate the  $\beta$  coefficient from the  $\phi'$  angle for each layer.

**STEP 3** For each soil layer compute the unit shaft resistance,  $f_s$  in ksf (kPa).

$$f_s = \beta p_o$$

**STEP 4** Compute the shaft resistance in each soil layer and the ultimate shaft resistance,  $R_s$  in kips (kN) from the sum of the shaft resistance from each soil layer.

$$R_s = \sum f_s A_s$$

where:  $A_s$  = pile-soil surface area in  $\text{ft}^2$  ( $\text{m}^2$ ) = (pile perimeter) x (length).

**STEP 5** Compute the unit toe resistance,  $q_t$  in ksf (kPa).

$$q_t = N_t p_t$$

- a. Use local experience to select  $N_t$  coefficient.
- b. In the absence of local experience, estimate  $N_t$  from Table 9-7 or Figure 9-18 based on  $\phi'$  angle.
- c. Calculate the effective overburden pressure at the pile toe,  $p_t$  in ksf (kPa).

**STEP 6** Compute the ultimate toe resistance,  $R_t$  in kips (kN).

$$R_t = q_t A_t$$

where:  $A_t$  = area of the pile toe in  $\text{m}^2$  ( $\text{ft}^2$ ).

**STEP 7** Compute the ultimate geotechnical pile capacity,  $Q_u$  in kips (kN).

$$Q_u = R_s + R_t$$

**STEP 8** Compute the allowable geotechnical soil resistance,  $Q_a$  in kips (kN).

$$Q_a = \frac{Q_u}{\text{Factor of Safety}}$$

The factor of safety in this static calculation should be based on the specified construction control method as described in Section 9.4 of this chapter. Recommended factors of safety based on construction control methods are listed in Table 9-5

The concepts discussed above are illustrated numerically in Example 9-3.

**Example 9-3:** Determine the required pile length to resist a 40 tons load with a safety factor of 2. Assume no toe resistance for the 1 ft<sup>2</sup> precast concrete pile. Site specific tests have indicated that the adhesion may be assumed equal to cohesion.

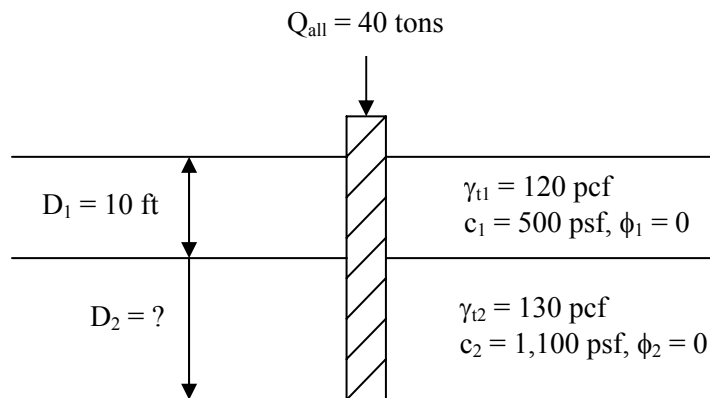

**Solution:**

$$Q_u = R_{s1} + R_{s2} \quad (\text{Note: No toe resistance, i.e. } 9 c_u A_t = 0)$$

$$Q_u = c_{a1} A_{s1} + c_{a2} A_{s2}$$

$$Q_u = c_{a1} C_{d1} D_1 + c_{a2} C_{d2} D_2$$

where  $C_{d1}$  and  $C_{d2}$  are pile perimeters within depths  $D_1$  and  $D_2$

$$C_{d1} = C_{d2} = 4 \times 1 \text{ ft} = 4 \text{ ft}$$

From the problem statement, for site-specific conditions, adhesion = cohesion. Therefore,

$$c_{a1} = c_1 = 500 \text{ psf}$$

$$c_{a2} = c_2 = 1,100 \text{ psf}$$

$$Q_u = 40 \text{ tons} \times \text{FS} = 40 \text{ tons} \times 2 = 80 \text{ tons}$$

$$80 \text{ tons} = (500 \text{ psf})(4 \text{ ft})(10 \text{ ft}) + (1,100 \text{ psf})(4 \text{ ft})D_2$$

$$80 \text{ tons} = 20,000 \text{ lbs} + 4,400 D_2 \text{ lbs/ft}$$

$$80 \text{ tons} = 10 \text{ tons} + 2.2 D_2 \text{ tons/ft}$$

Solve for  $D_2$ ,

$$D_2 = \frac{80 \text{ tons} - 10 \text{ tons}}{2.2 \text{ tons/ft}} \approx 32 \text{ ft}$$

$$\therefore \text{Total pile length required} = 32 \text{ ft} + 10 \text{ ft} \approx 42 \text{ ft}$$

### 9.5.3 Ultimate Geotechnical Capacity of Single Piles in Layered Soils

The ultimate capacity of piles in layered soils can be calculated by combining the methods previously described for cohesionless and cohesive soils. For example, a hand calculation combining the Nordlund method from Section 9.5.1.1 for cohesionless soil layers with the  $\alpha$ -method from Section 9.5.2.1 for cohesive soil layers could be used. The effective stress method as described in Section 9.5.2.2 could also be used for layered soil profiles.

#### 9.5.4 Plugging of Open Pile Sections

Open pile sections include open end pipe piles and H-piles. The use of open pile sections has increased, particularly where special design events dictate large pile penetration depths. When open pile sections are driven, they may behave as low displacement piles and "cookie cut" through the soil, or act as displacement piles if a soil plug forms near the pile toe. It is generally desired that open sections remain unplugged during driving and plugged under static loading conditions.

Stevens (1988) reported that plugging of pipe piles in clays does not occur during driving if pile accelerations along the plug zone are greater than 22g. Holloway and Beddard (1995) reported that hammer blow size influenced the dynamic response of the soil plug. With a large hammer blow, the plug "slipped" under the dynamic event whereas under a lesser hammer blow the pile encountered toe resistance typical of a plugged condition. From a design perspective, these cases indicate that pile penetration of open sections can be facilitated if the pile section is designed to accommodate a large pile hammer. Wave equation analyses can provide calculated accelerations at selected pile segments.

Static pile capacity calculations must determine whether an open pile section will exhibit plugged or unplugged behavior. Studies by O'Neill and Raines (1991), Raines, *et al.* (1992), as well as Paikowsky and Whitman (1990) suggest that plugging of open pipe piles in medium dense to dense sands generally begins at a pile penetration-to-pile-diameter ratio of 20, but can occur in cases where the ratio is as high as 35. For pipe piles in soft to stiff clays, Paikowsky and Whitman (1990) reported plugging occurs at penetration-to-pile-diameter ratios of 10 to 20.

The above studies suggest that plugging in any soil material is probable under static loading conditions once the penetration-to-pile-diameter ratio exceeds 20 in dense sands and clays, or 20 to 30 in medium sands. An illustration of the difference in the soil resistance mechanism that develops on a pipe pile with an open and plugged toe condition is presented in Figure 9-19. Paikowsky and Whitman (1990) recommend that the static capacity of an open end pipe pile be calculated from the lesser of the following equations:

$$\text{Plugged Condition:} \quad Q_u = f_{so} A_s + q_t A_t \quad 9-15a$$

$$\text{Unplugged Condition:} \quad Q_u = f_{so} A_s + f_{si} A_{si} + q_t A_p - w_p \quad 9-15b$$

where:  $Q_u$  = ultimate pile capacity in kips (kN).  
 $f_{so}$  = exterior unit shaft resistance in ksf (kPa).

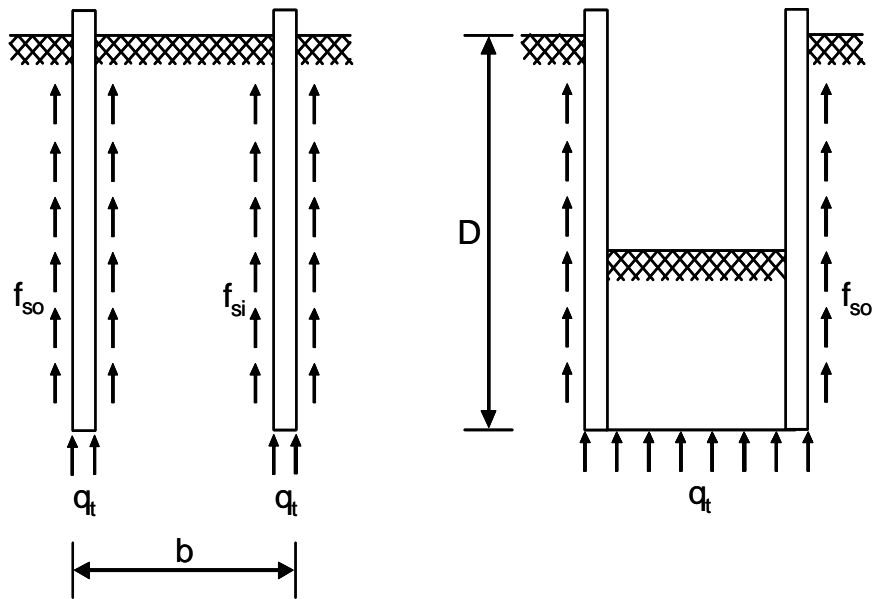

(a) Open Toe Condition

(b) Plugged Toe Condition

Figure 9-19. Plugging of open end pipe piles (after Paikowsky and Whitman, 1990).

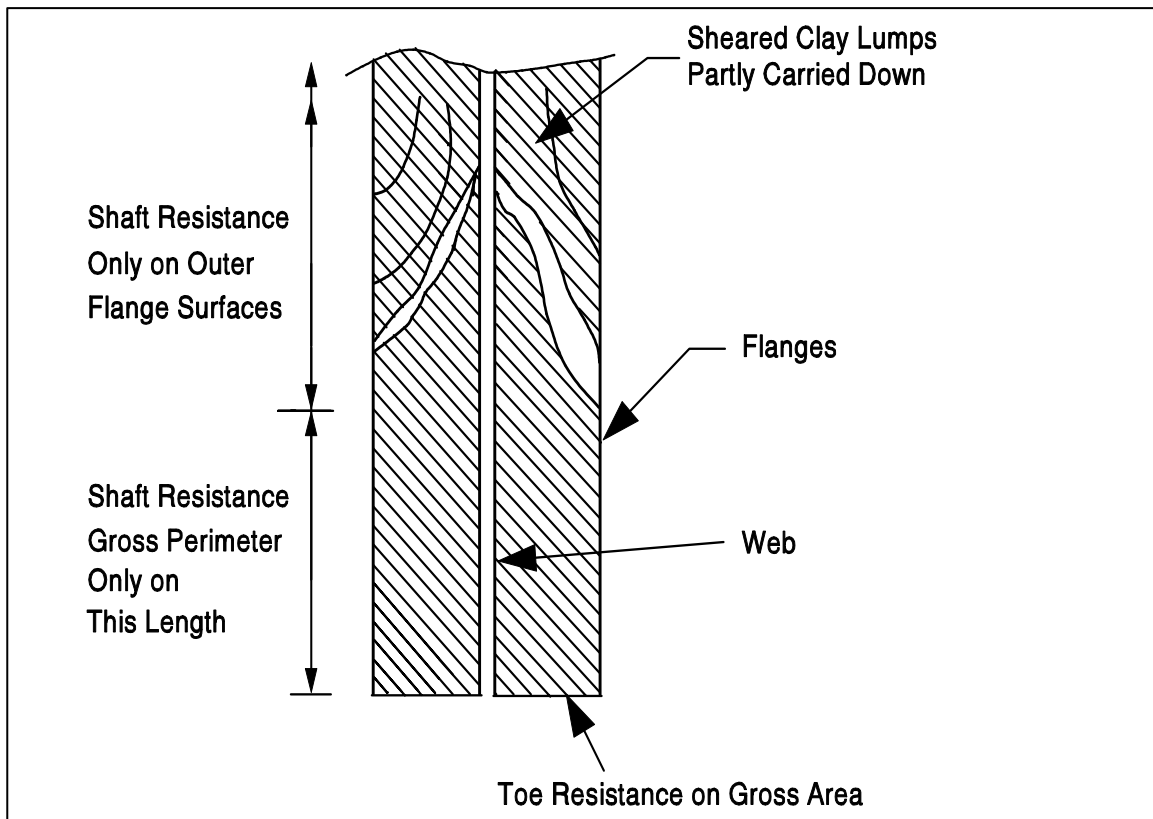

Figure 9-20. Plugging of H-piles (FHWA, 2006a).



$A_s$	= pile exterior surface area in $\text{ft}^2$ ( $\text{m}^2$ )
$f_{si}$	= interior unit shaft resistance in ksf (kPa)
$A_{si}$	= pile interior surface area in $\text{ft}^2$ ( $\text{m}^2$ )
$q_t$	= unit toe resistance in ksf (kPa)
$A_t$	= toe area of a plugged pile in $\text{ft}^2$ ( $\text{m}^2$ )
$A_p$	= cross sectional area of an unplugged pile in $\text{ft}^2$ ( $\text{m}^2$ )
$w_p$	= weight of the plug in kips (kN)

Static pile capacity calculations for open end pipe piles in cohesionless soils should be performed by using the Paikowsky and Whitman (1990) equations. Toe resistance should be calculated by using the Tomlinson limiting unit toe resistance of 105 ksf (5000 kPa), once Meyerhof's limiting unit toe resistance, determined from Figure 9-14, exceeds 105 ksf (5000 kPa). For open end pipe piles in predominantly cohesive soils, the Tomlinson equation should be used.

The soil stresses and displacements induced by driving an open pile section and a displacement pile section are not the same. Hence, a lower unit toe resistance,  $q_t$ , should be used for calculating the toe capacity of open end pipe piles compared to a typical closed end condition. The value of the interior unit shaft resistance in an open end pipe pile is typically on the order of 1/3 to 1/2 the exterior unit shaft resistance, and is influenced by soil type, pile diameter, and pile shoe configuration. These factors will also influence the length of the soil plug that may develop.

For open end pipe piles in cohesionless soils, Tomlinson (1994) recommends that the static pile capacity be calculated using a limiting value of 105 ksf (5000 kPa) for the unit toe resistance, regardless of the pile size or soil density. Tomlinson states that higher unit toe resistances do not develop, because yielding of the soil plug rather than bearing capacity failure of the soil below the plug governs the capacity.

For open end pipe piles driven in stiff clays, Tomlinson (1994) recommends that the static pile capacity for cohesive soils be calculated as follows when field measurements confirm a plug is formed and carried down with the pile:

$$Q_u = 0.8 c_a A_s + 4.5 c_u A_t \quad 9-16$$

where:	$Q_u$	= ultimate pile capacity in kips (kN)
	$c_a$	= pile adhesion from Figure 9-15 in ksf (kPa)
	$A_s$	= pile-soil surface area in $\text{ft}^2$ ( $\text{m}^2$ )
	$c_u$	= average undrained shear strength at the pile toe in ksf (kPa)

$A_t$  = toe area of a plugged pile in  $\text{ft}^2$  ( $\text{m}^2$ )

The plugging phenomenon in H-piles can be equally difficult to analyze. However, the distance between flanges of an H-pile is smaller than the inside diameter of most open end pipe piles. Therefore, it can usually be assumed that an H-pile will be plugged under static loading conditions and the “box” area of the pile toe can be used for static calculation of the toe capacity in cohesionless and cohesive soils, i.e., area = flange width x section height. The toe capacity for H-piles driven to rock is usually governed by the pile structural strength. In that case, the toe capacity is calculated based on the steel cross sectional area, and should not include the area of a soil plug, if any.

For H-piles in cohesionless soils, arching between the flanges can usually be assumed, and the "box" perimeter can be used for shaft resistance calculations, i.e., perimeter = 2 x flange width + 2 x section height. In most cohesive soils, the shaft resistance is calculated from the sum of the adhesion,  $c_a$ , along the exterior of the two flanges plus the undrained shear strength of the soil,  $c_u$ , times the section height surface area of the two remaining sides of the "box" due to soil-to-soil shear along these two faces. Figure 9-20 illustrates that calculation of shear resistance for H-piles in stiff clays can still be problematic. Sheared clay lumps can develop above the plug zone, in which case the shaft resistance may develop only along the exterior surfaces of the flanges in the sheared lump zone.

The above discussions highlight the point that a higher degree of uncertainty often exists for static pile capacity calculations of open pile sections than for displacement piles. Soil plug formation and plug response is often different under static and dynamic loading. Such differences can complicate pile capacity evaluations of open pile sections with all dynamic methods (wave equation, dynamic testing, and dynamic formulas). Therefore, a static load test is recommended to verify calculated capacity for large diameter open end pipe piles, greater than 18 in (450 mm), or for H-piles designed to carry their load primarily in shaft resistance.

### 9.5.5 Time Effects on Pile Capacity

The soil is greatly disturbed when a pile is driven into the soil. As the soil surrounding the pile recovers from the installation disturbance, a time dependent change in pile capacity often occurs. Frequently piles driven in saturated clays, and loose to medium dense silts or fine sands gain capacity after driving has been completed. This phenomenon is called **soil setup**. Occasionally piles driven into dense saturated fine sands, dense silts, or weak laminated rocks such as shale, will exhibit a decrease in capacity after the driving has been completed. This phenomenon is called **relaxation**. Case history discussions on soil setup and relaxation may be found in Fellenius, *et al.* (1989), and Thompson and Thompson (1985), respectively.

#### 9.5.5.1 Soil Setup

When saturated cohesive soils are compressed and disturbed due to pile driving, large excess pore water pressures develop. These excess pore water pressures are generated partly from the shearing and remolding of the soil and partly from radial compression as the pile displaces the soil. The excess pore water pressures cause a reduction in the effective stresses acting on the pile, and thus a reduction in the soil shear strength. The reduction in soil shear strength results in a reduced pile capacity during driving, and for a period of time afterwards.

After driving, the excess pore water pressures will dissipate primarily through radial flow of the pore water away from the pile. With the dissipation of pore water pressures, the soil reconsolidates and shear strength increases. This increase in soil shear strength results in an increase in the static pile capacity and is called **soil setup**. A similar decrease in resistance to pile penetration with subsequent soil setup may occur in loose to medium dense, saturated, fine grained sands or silts. The magnitude of the gain in capacity depends on soil characteristics, pile material and pile dimensions.

Because the pile capacity may increase after the end of driving, pile capacity assessments should be made from static load testing or **restriking** performed **after** equilibrium conditions in the soil have been re-established. The time for the return of equilibrium conditions is highly variable and depends on soil type and degree of soil disturbance. Piezometers installed within three diameters of the pile can be used to monitor pore pressure dissipation with time. Effective stress static pile capacity calculation methods can be used to evaluate the increase in capacity with time once pore pressures are quantified.

Static load testing or **restrike** testing of piles in fine grained soils should not be conducted until after pore pressures dissipate and return to equilibrium. In the absence of site-specific pore water

pressure data from piezometers, it is suggested that static load testing or restriking of piles in clays and other predominantly fine grained soils be delayed for at least two weeks after driving and preferably for a longer period. In sandy silts and fine sands, pore pressures generally dissipate more rapidly. In these more granular deposits, five days to a week is often a sufficient time delay.

FHWA (1996) calculated general soil setup factors based on the predominant soil type along the pile shaft. The **soil setup factor** was defined as the failure load from a static load test divided by the end-of-drive wave equation capacity. These results are presented in Table 9-20. The data base for this study was comprised of 99 test piles from 46 sites. The number of sites and the percentage of the data base in a given soil condition is included in the table. While these soil set-up factors may be useful for preliminary estimates, soil setup is better estimated based on site-specific data gathered from pile restriking, dynamic measurements, static load testing, and local experience.

Komurka, *et al.*, (2003) summarized the current practice in estimating and measuring soil setup in a report to the Wisconsin Highway Research Program. This report summarizes the mechanisms associated with soil setup development and reviews several empirical relationships for estimating set-up.

**Table 9-8**  
**Soil setup factors (after FHWA, 1996)**

Predominant Soil Type Along Pile Shaft	Range in Soil Set-up Factor	Recommended Soil Set-up Factors*	Number of Sites and (Percentage of Data Base)
Clay	1.2 - 5.5	2.0	7 (15%)
Silt - Clay	1.0 - 2.0	1.0	10 (22%)
Silt	1.5 - 5.0	1.5	2 (4%)
Sand - Clay	1.0 - 6.0	1.5	13 (28%)
Sand - Silt	1.2 - 2.0	1.2	8 (18%)
Fine Sand	1.2 - 2.0	1.2	2 (4%)
Sand	0.8 - 2.0	1.0	3 (7%)
Sand - Gravel	1.2 - 2.0	1.0	1 (2%)
* Confirmation with local experience recommended			

### 9.5.5.2 Relaxation

The ultimate capacity of driven piles can also decrease with time following driving. This is known as **relaxation** and it has been observed in dense, saturated, fine grained soils such as non-cohesive silts and fine sands, as well as in some shales. In these cases, the driving process is believed to cause the dense soil near the pile toe to dilate, thereby generating negative excess

pore water pressures, i.e., suction. In accordance with the principle of effective stress, the negative pore water pressures temporarily increase the effective stresses acting on the pile, resulting in a temporarily higher soil strength and driving resistance. When these negative excess pore water pressures dissipate, the effective stresses acting on the pile decrease, as does the pile capacity. Relaxation in weak laminated rocks has been attributed to a release of locked-in horizontal stresses (Thompson and Thompson, 1985).

Because the pile capacity may decrease due to relaxation after the end of driving, pile capacity assessments from static load testing or restriking should be made after equilibrium conditions in the soil have been re-established. In the absence of site-specific pore water pressure data from piezometers, it is suggested that static load testing or restriking of piles in dense silts and fine sands be delayed for five days to a week after driving, or longer if possible. In relaxation-prone shales, it is suggested that static load testing or restrike testing be delayed a minimum of two weeks after driving.

Published cases of the relaxation magnitude of various soil types are quite limited. However, data from Thompson and Thompson (1985) as well as Hussein, *et al.* (1993) suggest relaxation factors for piles founded in some shales can range from 0.5 to 0.9. The **relaxation factor** is defined as the failure load from a static load test divided by the pile capacity at the end of initial driving. Relaxation factors of 0.5 and 0.8 have also been observed in two cases where piles were founded in dense sands and extremely dense silts, respectively. The importance of evaluating time dependent decreases in pile capacity for piles founded in these materials cannot be over emphasized.

### **9.5.6 Additional Design and Construction Considerations**

The previous sections of this chapter addressed routine static analysis procedures for pile foundation design. However, the designer should be aware of additional design and construction considerations that can influence the reliability of static analysis procedures in estimating pile capacity. These issues include effects of predrilling or jetting, construction dewatering and soil densification on pile capacity. Pile-driving-induced vibrations can also influence the final design and results of static calculations if potential vibration levels dictate changes in pile type or installation procedures. These topics are outside the scope of this manual and the reader is referred to FHWA (2006a) for guidance.

### 9.5.7 The DRIVEN Computer Program

The FHWA developed the computer program DRIVEN in 1998 for calculation of static pile capacity. The DRIVEN program can be used to calculate the capacity of open and closed end pipe piles, H-piles, circular or square solid concrete piles, timber piles, and Monotube piles. The program results can be displayed in both tabular and graphical form. Analyses may be performed in either English or SI units and can be switched between units during analyses (FHWA, 1998b). The DRIVEN manual and software Version 1.2, released in March 2001, can be downloaded from [www.fhwa.dot.gov/bridge/geosoft.htm](http://www.fhwa.dot.gov/bridge/geosoft.htm).

In the DRIVEN program, the user inputs the soil profile consisting of the soil unit weights and strength parameters including the percentage strength loss during driving. For the selected pile type, the program calculates the pile capacity versus depth for the entire soil profile using the Nordlund and  $\alpha$ -methods in cohesionless and cohesive layers, respectively. User-input percentage soil strength losses during driving are used to calculate the ultimate pile capacity at the time of driving as well as during restrike.

The DRIVEN program includes several analysis options that facilitate pile design. These options include:

- **Soft compressible soils:** The shaft resistance from unsuitable soil layers defined by the user is subtracted from the calculation of ultimate pile capacity.
- **Scourable soils:** Based on a user-input depth, the calculated shaft resistance from scourable soils due to local scour is subtracted from the calculation of ultimate pile capacity. In the case of channel degradation scour, the reduction in pile capacity from the loss of shaft resistance in the scour zone as well as the influence of the reduced effective overburden pressure from soil removal on the capacity calculated in the underlying layers is considered.
- **Pile Plugging:** DRIVEN handles pile plugging based on the recommendations presented in Section 9.5.4 of this manual.

The initial DRIVEN program screen is the Project Definition Screen illustrated in Figure 9-21. In this screen the user inputs the project information as well as the number of soil layers. Inputs for three water table elevations are provided. The water table at the time of drilling is used for correction of SPT N values for overburden pressure if that option is selected by the user. The

water table at the time of restrike / driving affects the effective overburden pressure in the static capacity calculations at those times. The static calculation at the time of driving includes soil strength losses. The restrike static calculations include the long term soil strength. The water table at the ultimate condition is used in the calculation of effective overburden pressure for the static capacity calculation under an extreme event.

The Soil Profile screen for a two layer soil profile is shown in Figure 9-22. A mouse click on the Select Graph Option will bring up the Cohesive Soil Layer Properties screen shown in Figure 9-23. The user can then select how the adhesion is calculated. The general adhesion option attributed to “Tomlinson 1979” in Figure 9-23 is based upon the data presented in Figure 9-16, i.e., piles without different overlying strata. The bottom option in the Cohesive Soil Layer Properties screen shown in Figure 9-23 allows the user to enter an adhesion value of their choice. This bottom option may be useful with the data presented in Figures 9-15 and 9-16 or site data from specific load test..

The Soil Profile screen for a two layer profile with cohesionless soil properties is presented in Figure 9-24. The user can input the same or different soil friction angles to be used in the shaft resistance and end bearing calculations in the layer. The user can also input SPT N values and let the program compute the soil friction angle from a correlation developed by Peck, *et al.* (1974) as shown in Figure 9-25. However, it is recommended that the user manually select the soil friction angle rather than use this program option as factors influencing the N value -  $\phi$  angle correlation such as SPT hammer type and sample recovery are not considered by the program.

Both cohesive and cohesionless soil profile screens request the user to provide the percentage strength loss of the soil type during driving. This is sometimes difficult for the user to quantify. Insight into appropriate values of driving strength loss can be gathered from the soil setup factors presented in Section 9.5.5. The percent driving strength loss needed for input into DRIVEN can be then be calculated from:

$$\% \text{ Driving Strength Loss} = 1 - [1 / \text{setup factor}]$$

After the soil input has been entered, the user must select a pile type from a drop down menu located on the Soil Profile screen. A pile detail screen will appear for the pile type selected requesting additional information on the depth to the top of the pile and the pile properties. These DRIVEN screens are presented in Figure 9-26.

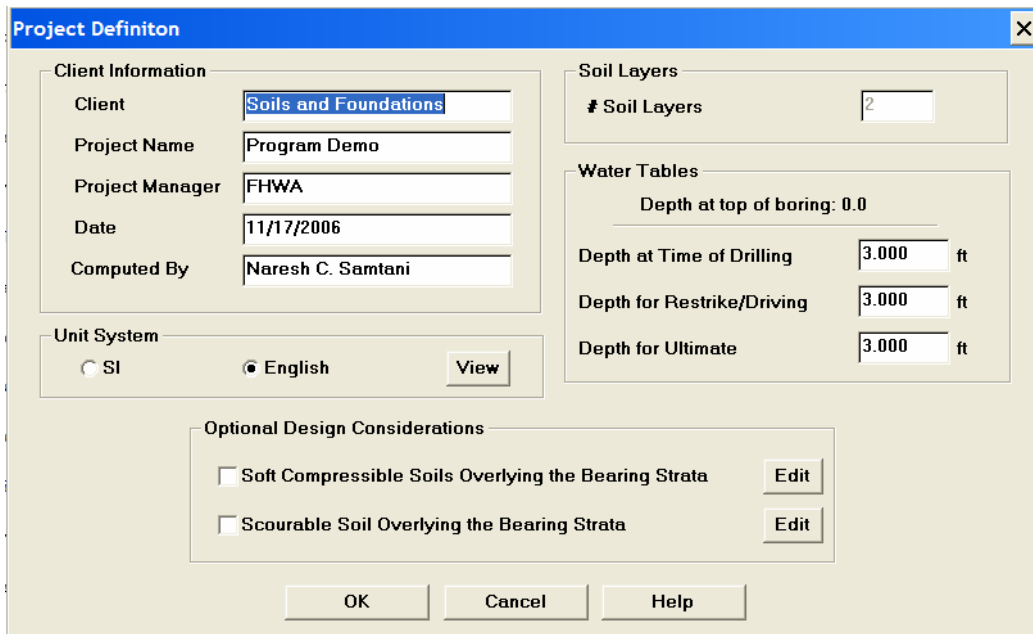

Figure 9-21. DRIVEN Project Definition screen.

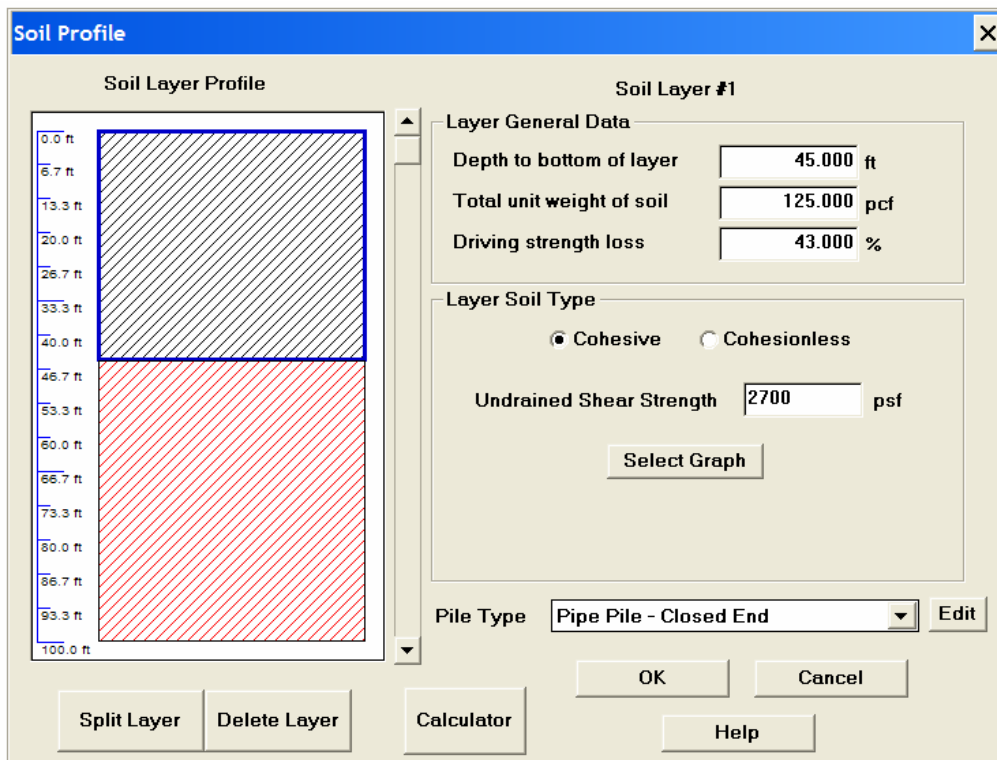

Figure 9-22. DRIVEN Soil Profile screen – cohesive soil.



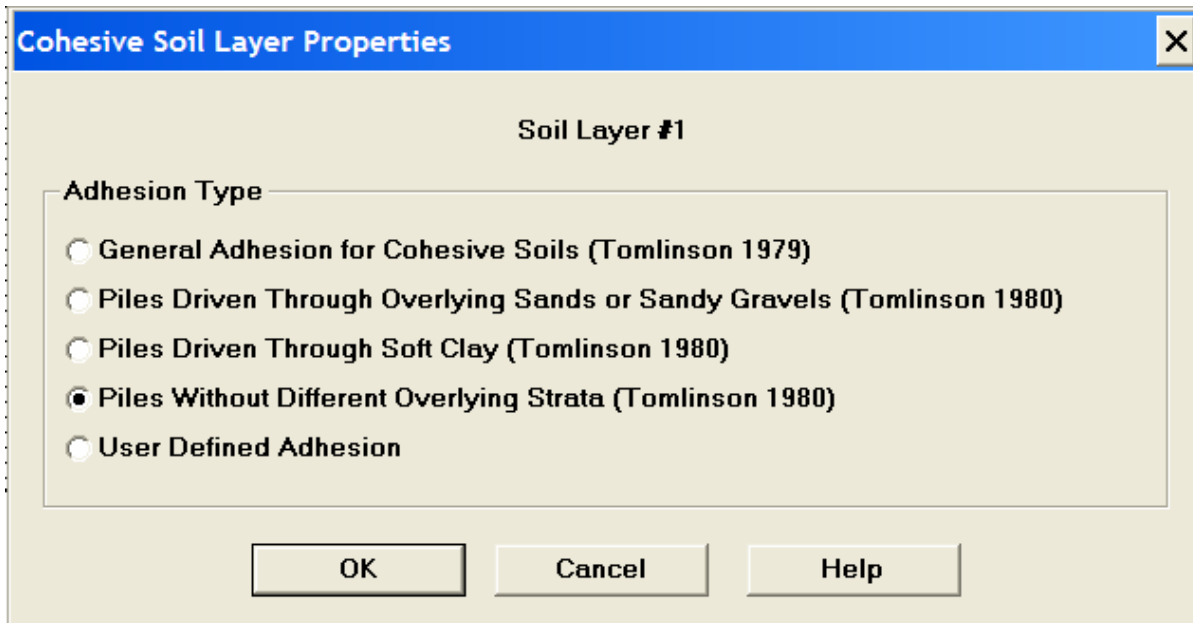

Figure 9-23. DRIVEN Cohesive Soil Layer Properties screen.

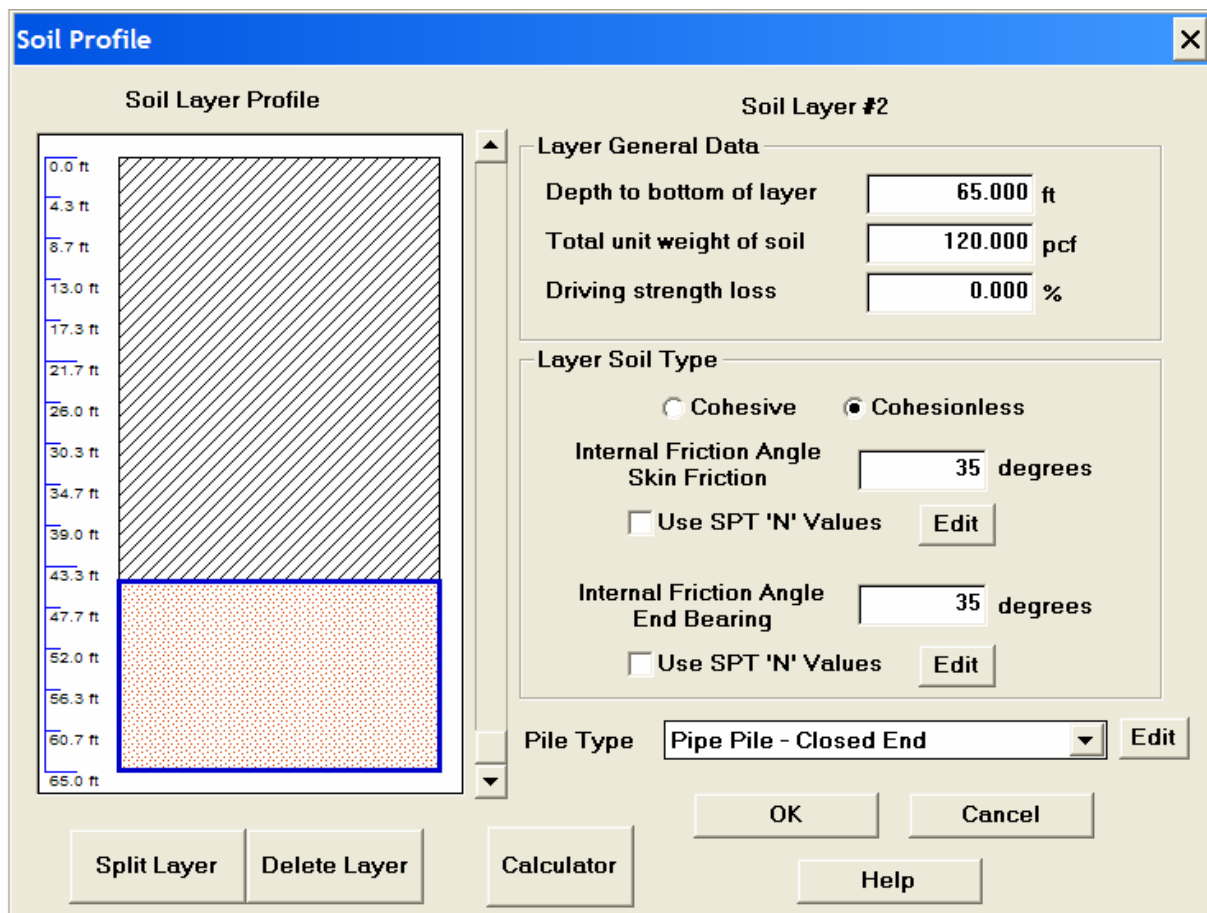

Figure 9-24. DRIVEN Soil Profile screen – cohesionless soil.

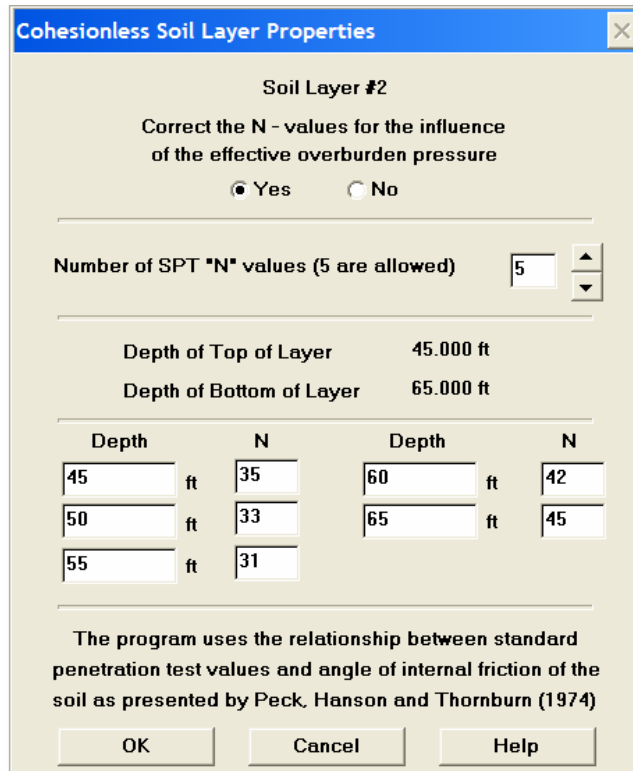

Figure 9-25. DRIVEN Cohesionless Soil Layer Properties screen.

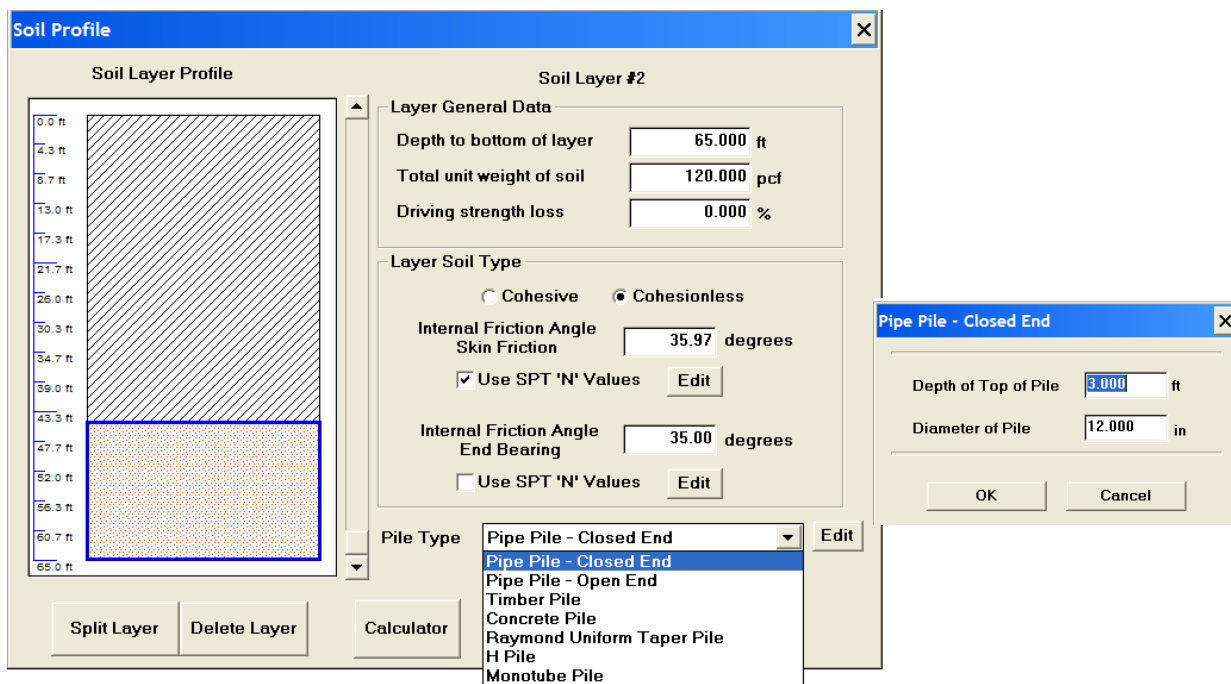

Figure 9-26. DRIVEN Soil Profile screen - Pile type selection drop down menu and pile detail screen.

Once all soil and pile information is entered, the user can review the static capacity calculations in tabular or graphical form by a mouse click on the appropriate icon in the program toolbar. The toolbar icons for tabular and graphical output are identified in Figure 9-27. The Output-Tabular screen is shown in Figure 9-28. A summary of the input data and the results of the analysis will be printed if the user clicks on the report button. Analysis output can also be presented graphically as shown in Figures 9-28 and 9-29 for driving and restrike static analyses, respectively. The ultimate capacity versus depth from shaft resistance, toe resistance, and the combined shaft and toe resistance can be displayed by clicking on “skin friction,” “end bearing,” and “total capacity” on the Plots menu of the Output-Graphical screen, capacity changes with time or from extreme events can be reviewed by clicking on “restrike,” “driving,” and “ultimate” on the Plot Set menu of the Output-Graphical screen.

The program also generates the soil input file required for a driveability study in the commonly used GRLWEAP wave equation program. The GRLWEAP file created by DRIVEN is compatible with the Windows versions of GRLWEAP. However, the DRIVEN file must be identified as a pre 2002 input file in the current version of GRLWEAP.

Additional DRIVEN program capabilities are described in the DRIVEN Program User’s Manual by FHWA (1998b).

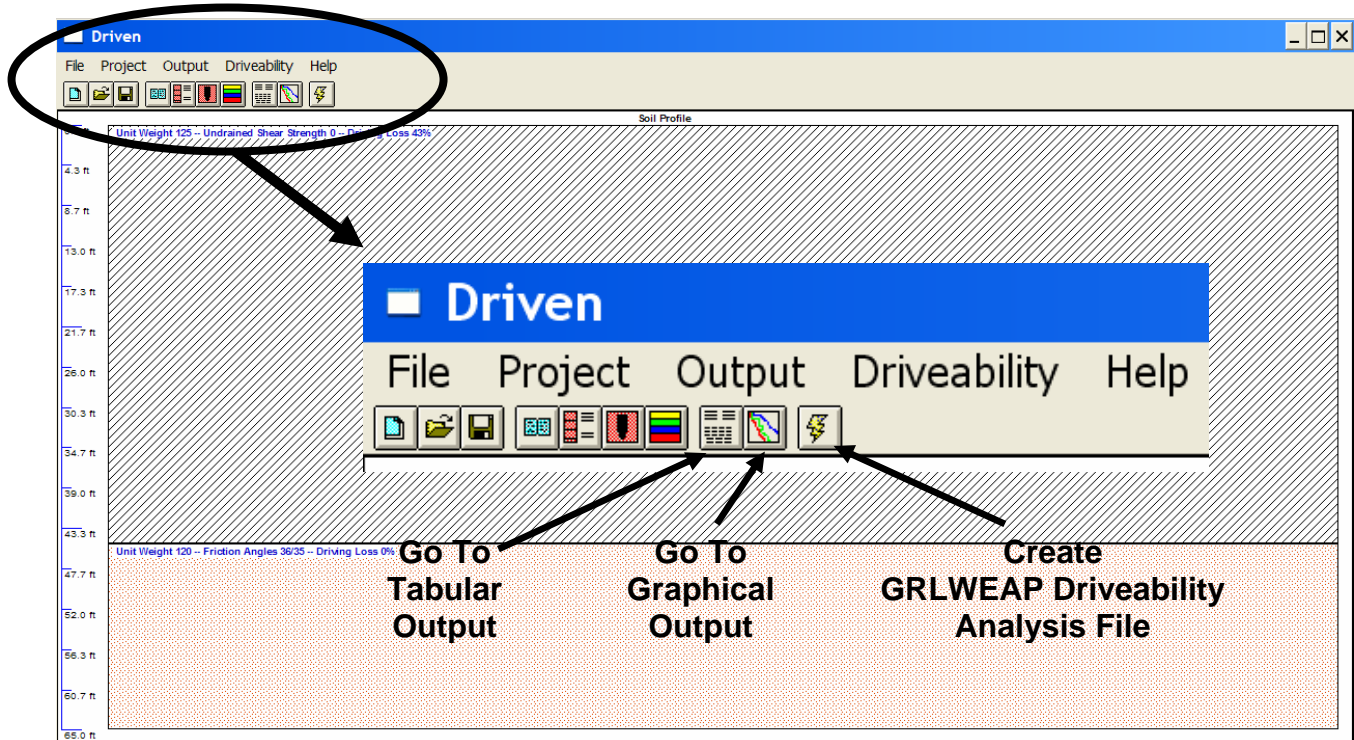
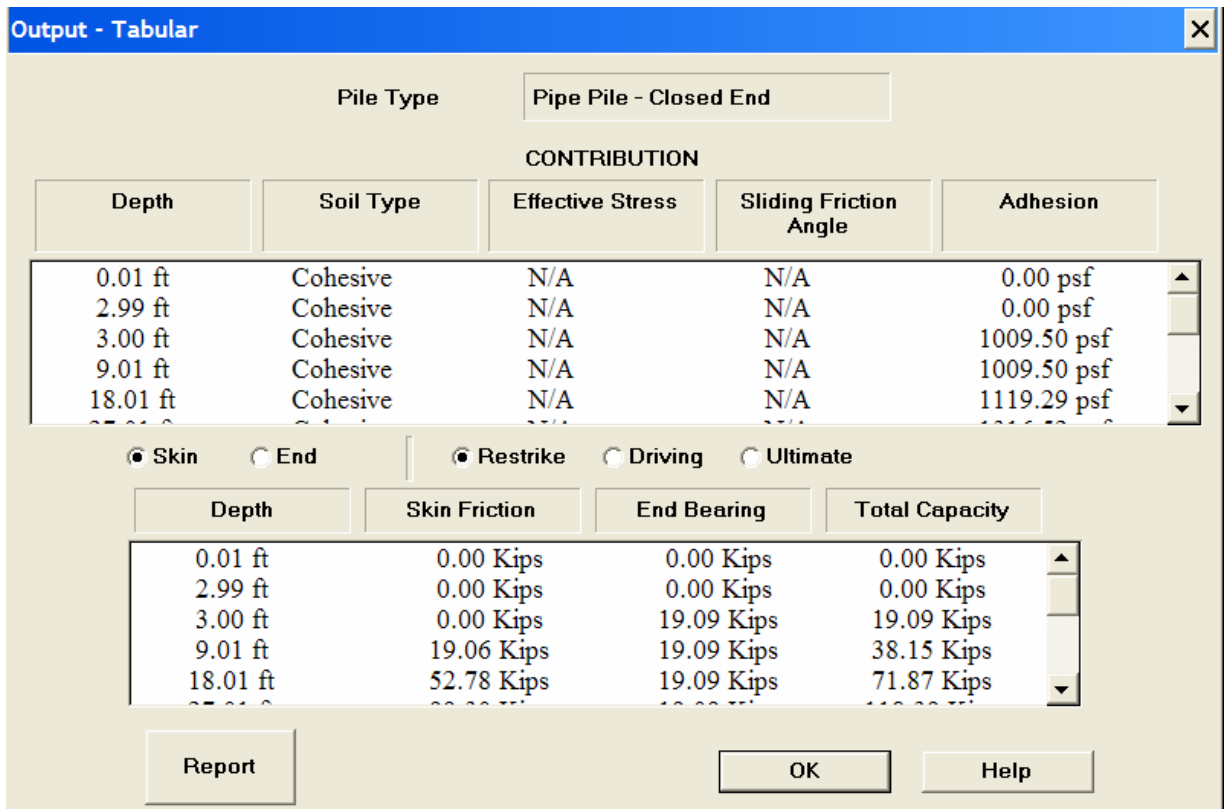

Figure 9-27. DRIVEN toolbar output and analysis options.



**Figure 9-28. DRIVEN Output Tabular screen.**

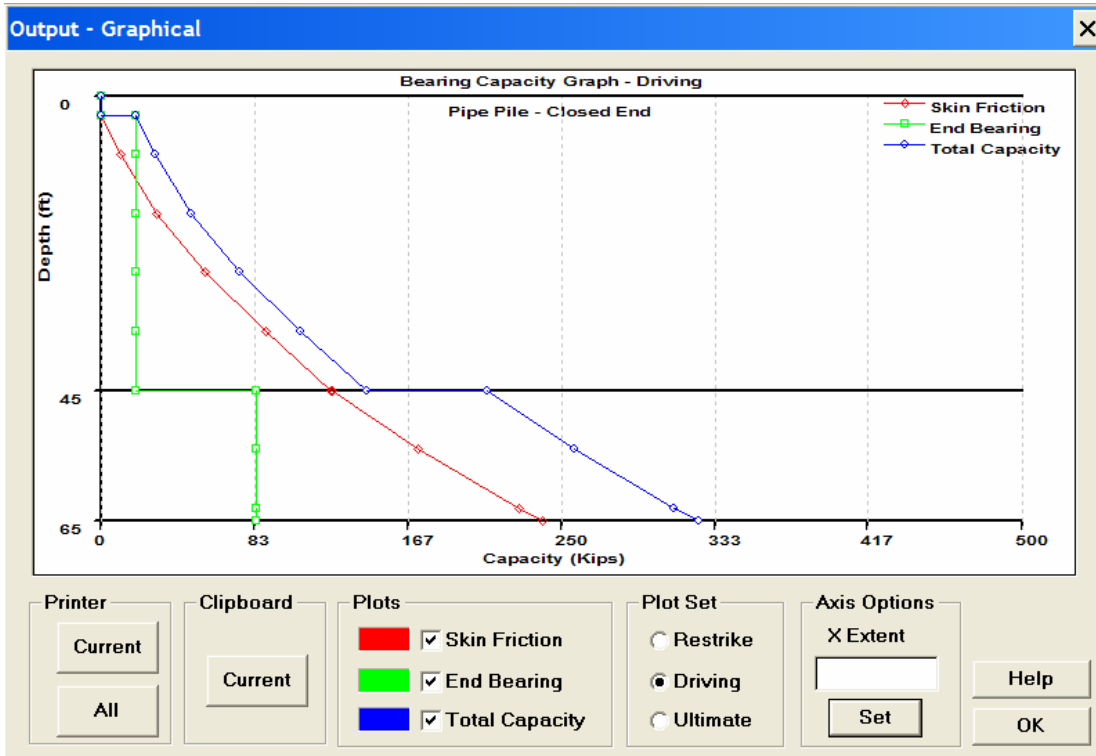

Figure 9-29. DRIVEN Output-Graphical screen for end of driving.

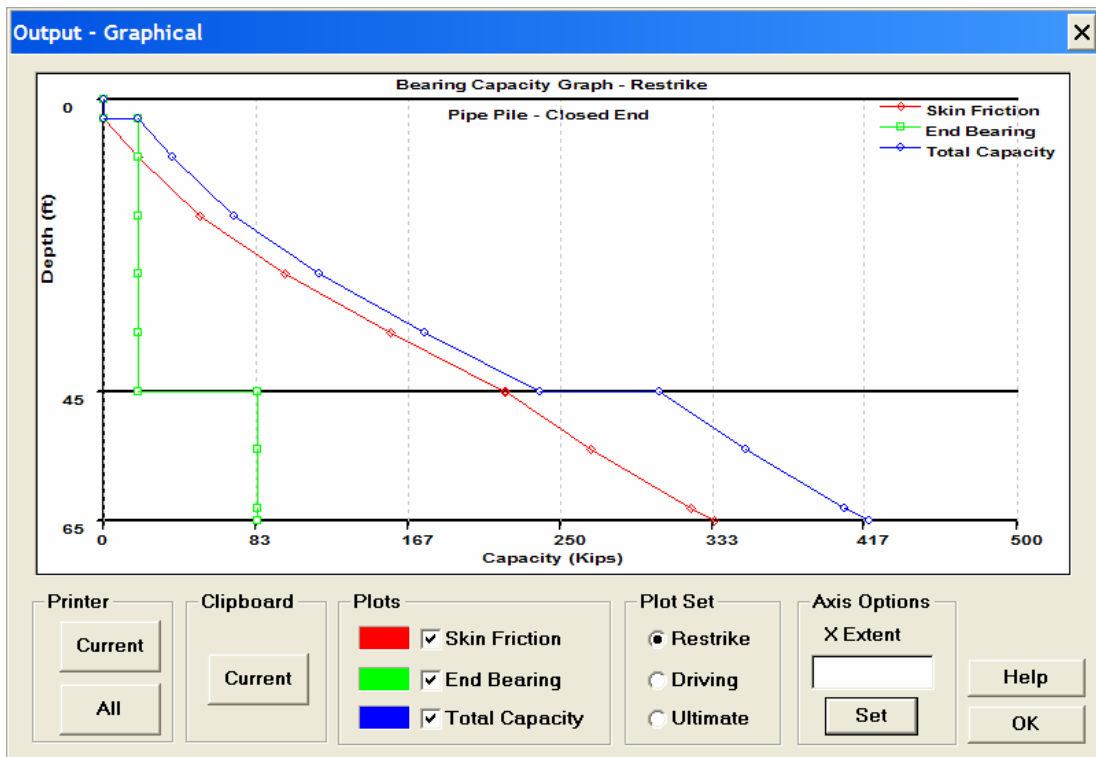

Figure 9-30. DRIVEN Output -Graphical screen for restrike.

### **9.5.8 Ultimate Capacity of Piles on Rock and in Intermediate Geomaterials (IGMs)**

Pile foundations on rock are normally designed to carry large loads. For pile foundations driven to rock, which include steel H-piles, pipe piles or precast concrete piles, the exact area in contact with the rock, the depth of penetration into rock, as well as the quality of rock are largely unknown. Therefore, the determination of load capacity of driven piles on rock should be made on the basis of driving observations, local experience and load tests.

Rock Quality Designation (RQD) values can provide a qualitative assessment of rock mass as discussed in Chapter 3. Except for soft weathered rock, the structural capacity of toe bearing pile will generally be less than the capacity of rock of fair to excellent quality as described in Figure 3-17 in Chapter 3. The structural capacity, which is based on the allowable design stress for the pile material, will therefore govern the pile capacity in many cases.

Small diameter piles supported on fair to excellent quality rock may be loaded to their allowable structural capacity. Piles supported on soft weathered rock, such as shale or other types of very poor or poor quality rock, should be designed based on the results of pile load tests. Similarly, for driven piles that penetrate into soft rocks or IGMs, the ultimate capacity may include the contribution of shaft resistance if a static load test is performed to verify the magnitude of the shaft resistance.

## 9.6 DESIGN OF PILE GROUPS

The previous sections of this chapter dealt with design procedures for single piles. However piles for almost all highway structures are installed in groups due to the heavy foundation loads. This section of the chapter will address the foundation design procedures for evaluating the axial compression capacity of pile groups as well as the settlement of pile groups under axial compression loads. The axial compression capacity and settlement of pile groups are interrelated and are therefore presented in sequence.

The efficiency of a pile group in supporting the foundation load is defined as the ratio of the ultimate capacity of the group to the sum of the ultimate capacities of the individual piles comprising the group. This may be expressed in equation form as:

$$\eta_g = \frac{Q_{ug}}{nQ_u} \quad 9-17$$

where:  $\eta_g$  = pile group efficiency  
 $Q_{ug}$  = ultimate capacity of the pile group  
 $n$  = number of piles in the pile group  
 $Q_u$  = ultimate capacity of each individual pile in the pile group

If piles are driven into compressible cohesive soil or into dense cohesionless material underlain by compressible soil, then the ultimate axial compression capacity of a pile group may be less than that of the sum of the ultimate axial compression capacities of the individual piles. In this case, the pile group has a group efficiency of less than 1. In cohesionless soils, the ultimate axial compression capacity of a pile group is generally greater than the sum of the ultimate axial compression capacities of the individual piles comprising the group. In this case, the pile group has a group efficiency greater than 1.

The settlement of a pile group is likely to be many times greater than the settlement of an individual pile carrying the same per pile load as each pile in the group. Figure 9-31(a) illustrates that for a single pile, only a relatively small zone of soil around and below the pile toe is subjected to vertical stress. Figure 9-31(b) illustrates that for a pile group, a much larger zone of soil around and below the pile group is stressed. The settlement of the pile group may be large depending on the compressibility of the soils within the stressed zone.

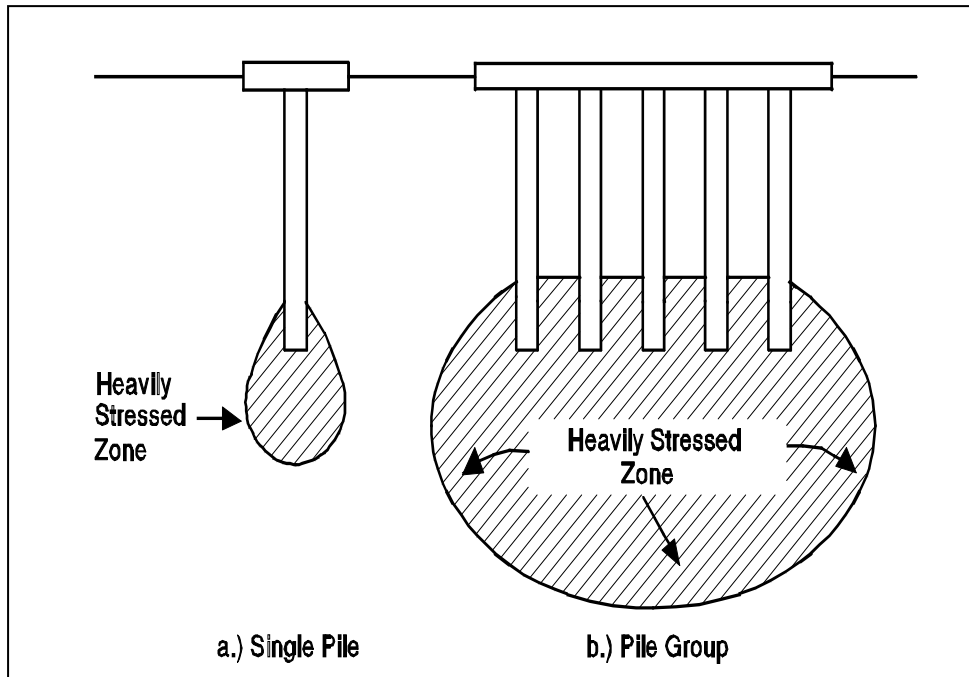

Figure 9-31. Stress zone from single pile and pile group (after Tomlinson, 1994).

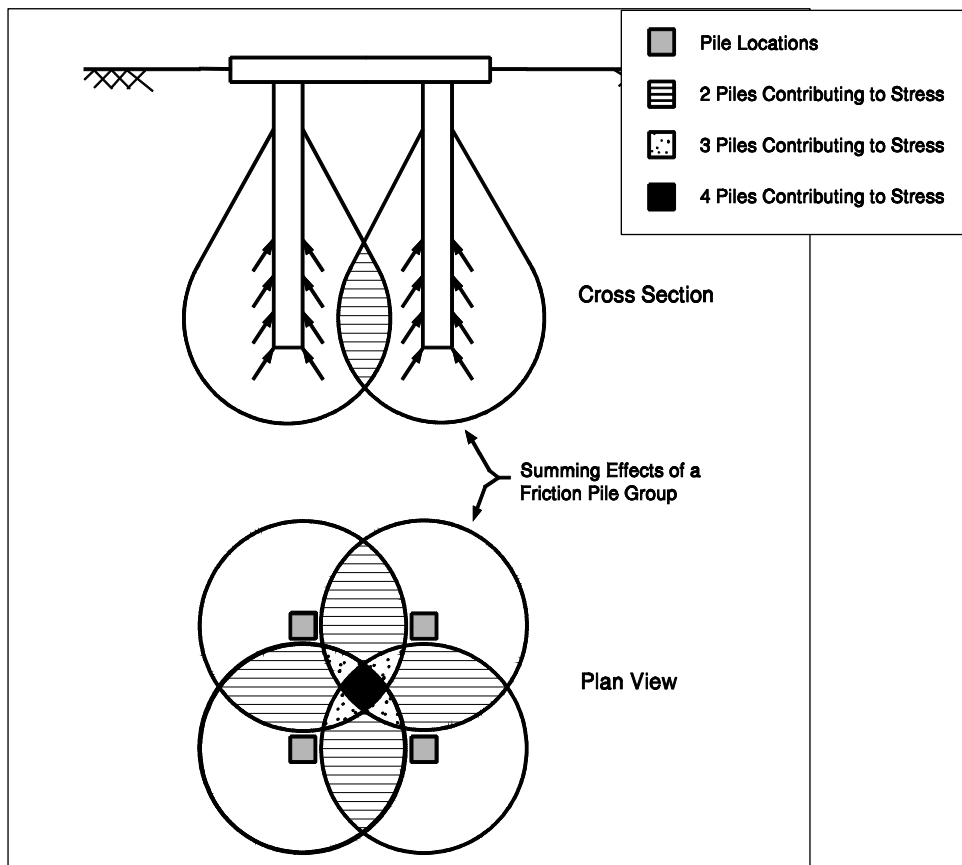

Figure 9-32. Overlap of stress zones for friction pile group (after Bowles, 1996).



The soil supporting a pile group is also subject to overlapping stress zones from individual piles in the group. The overlapping effect of stress zones for a pile group supported by shaft resistance is illustrated in Figure 9-32.

## **9.6.1 Axial Compression Capacity of Pile Groups**

### **9.6.1.1 Cohesionless Soils**

In cohesionless soils, the ultimate group capacity of driven piles with a center to center spacing of less than 3 pile diameters is greater than the sum of the ultimate capacity of the individual piles. The greater group capacity is due to the overlap of individual soil compaction zones around each pile, which increases the shaft resistance due to soil densification. Piles in groups at center to center spacings greater than three times the average pile diameter generally act as individual piles.

Design recommendations for estimating group capacity for driven piles in cohesionless soil are as follows:

1. The ultimate group capacity for driven piles in cohesionless soils not underlain by a weak deposit may be taken as the sum of the individual ultimate pile capacities, provided jetting or predrilling was not used in the pile installation process. Jetting or predrilling can result in group efficiencies less than 1. Therefore, jetting or predrilling should be avoided whenever possible or controlled by detailed specifications when necessary.
1. If a pile group founded in a firm bearing stratum of limited thickness is underlain by a weak deposit, then the ultimate group capacity is the smaller value of either the sum of the ultimate capacities of the individual piles, or the group capacity against block failure of an equivalent pier, consisting of the pile group and enclosed soil mass punching through the firm stratum into the underlying weak soil. From a practical standpoint, block failure in cohesionless soils can only occur when the center to center spacing of the piles is less than 2 pile diameters, which is less than the minimum center to center spacing of 2.5 diameters allowed by the AASHTO code (2002). The method shown for cohesive soils presented in the Section 9.6.1.3 may be used to evaluate the possibility of a block failure.
3. Piles in groups should not be installed at center to center spacings less than 3 times the average pile diameter. A minimum center to center spacing of 3 diameters is recommended to optimize group capacity and minimize installation problems.

### 9.6.1.2 Cohesive Soils

In the absence of negative shaft resistance, the group capacity in cohesive soil is usually governed by the sum of the ultimate capacities of the individual piles, with some reduction due to overlapping zones of shear deformation in the surrounding soil. Negative shaft resistance is described in Section 9.8 and often occurs when soil settlement transfers load to the pile. The AASHTO (2002) code states that the group capacity is influenced by whether or not the pile cap is in firm contact with the ground. If the pile cap is in firm contact with the ground, the soil between the piles and the pile group act as a unit.

The following design recommendations are for estimating ultimate pile group capacity in cohesive soils. The lesser of the ultimate pile group capacity, calculated from Steps 1 to 4, should be used.

1. For pile groups driven in clays with undrained shear strengths of less than 2 ksf (95 kPa) and for the pile cap not in firm contact with the ground, a group efficiency of 0.7 should be used for center to center pile spacings of 3 times the average pile diameter. If the center to center pile spacing is greater than 6 times the average pile diameter, then a group efficiency of 1.0 may be used. Linear interpolation should be used for intermediate center to center pile spacings.
2. For pile groups driven in clays with undrained shear strengths less than 2 ksf (95 kPa) and for the pile cap in firm contact with the ground, a group efficiency of 1.0 may be used.
3. For pile groups driven in clays with undrained shear strength in excess of 2 ksf (95 kPa), a group efficiency of 1.0 may be used regardless of the pile cap - ground contact.
4. Calculate the ultimate pile group capacity against block failure by using the procedure described in Section 9.6.1.3.
5. Piles in groups should not be installed at center to center spacings less than 3 times the average pile diameter and not less than 3 ft (1 m).

It is important to note that the driving of pile groups in cohesive soils can generate large excess pore water pressures. The excess pore water pressures can result in short term group efficiencies on the order of 0.4 to 0.8 for 1 to 2 months after installation. As these excess pore water pressures dissipate, the pile group efficiency will increase. Figure 9-33 presents observations on the dissipation of excess pore water pressure versus time for pile groups driven in cohesive soils.

Depending upon the group size, the excess pore water pressures typically dissipate within 1 to 2 months after driving. However, in very large groups, full excess pore water pressure dissipation may take up to a year.

If a pile group will experience the full group load shortly after construction, the foundation designer must evaluate the reduced group capacity that may be available for load support. In these cases, piezometers should be installed to monitor pore pressure dissipation with time. Effective stress capacity calculations can then be used to determine if the increase in pile group capacity versus time during construction meets the load support requirements.

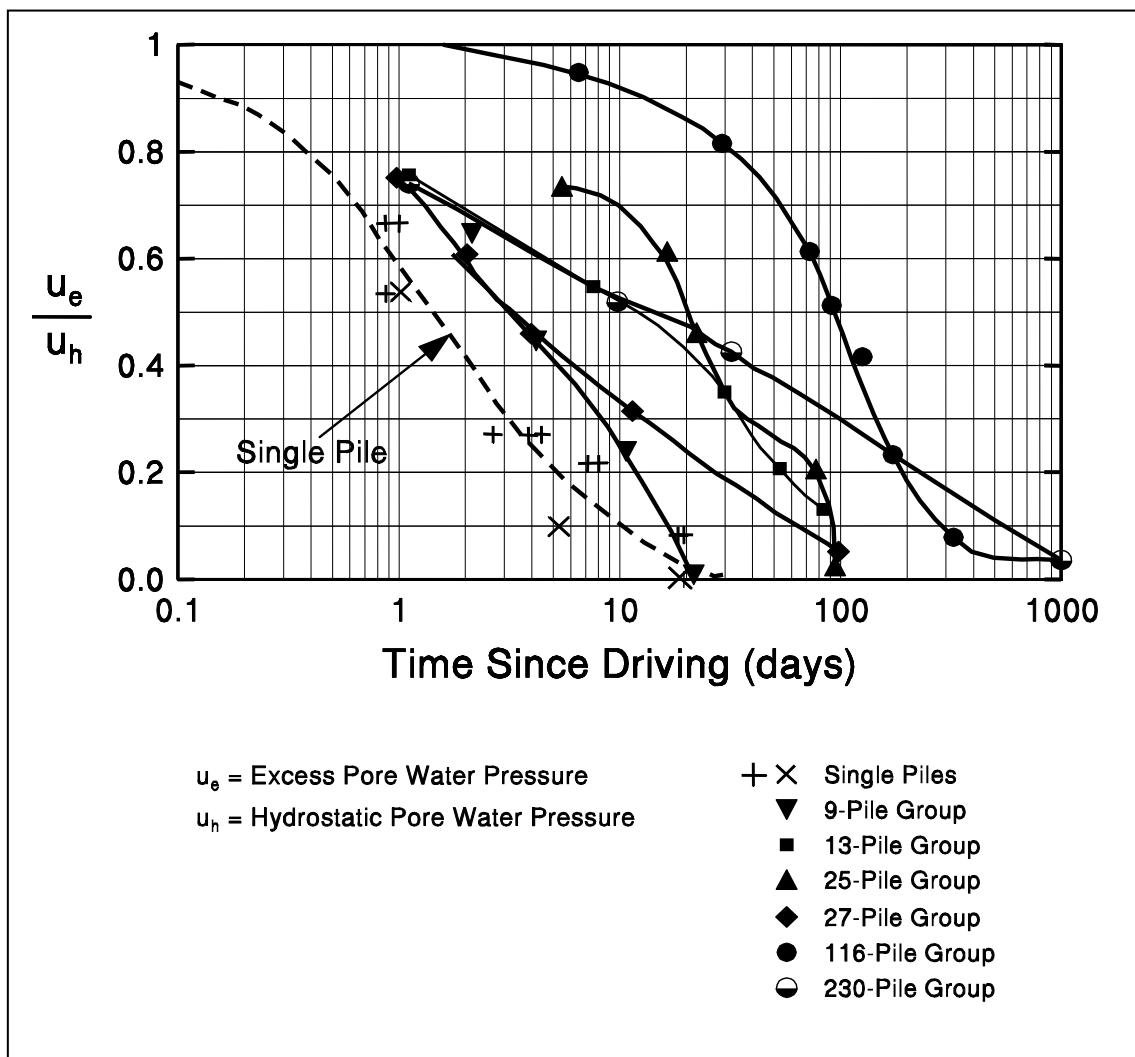

Figure 9-33. Measured dissipation of excess pore water pressure in soil surrounding full scale pile groups (after O'Neill, 1983).

### 9.6.1.3 Block Failure of Pile Groups

Block failure of pile groups is generally a design consideration only for pile groups in soft cohesive soils or in cohesionless soils underlain by a weak cohesive layer. For a pile group in cohesive soil as shown in Figure 9-34, the ultimate capacity of the pile group against a block failure is provided by the following expression:

$$Q_{ug} = 2D (B + Z) c_{u1} + B Z c_{u2} N_c \quad 9-18$$

- where:
- $Q_{ug}$  = ultimate group capacity against block failure
  - $D$  = embedded length of piles
  - $B$  = width of pile group
  - $Z$  = length of pile group
  - $c_{u1}$  = weighted average of the undrained shear strength over the depth of pile embedment for the cohesive soils along the pile group perimeter
  - $c_{u2}$  = average undrained shear strength of the cohesive soils at the base of the pile group to a depth of  $2B$  below pile toe level
  - $N_c$  = bearing capacity factor

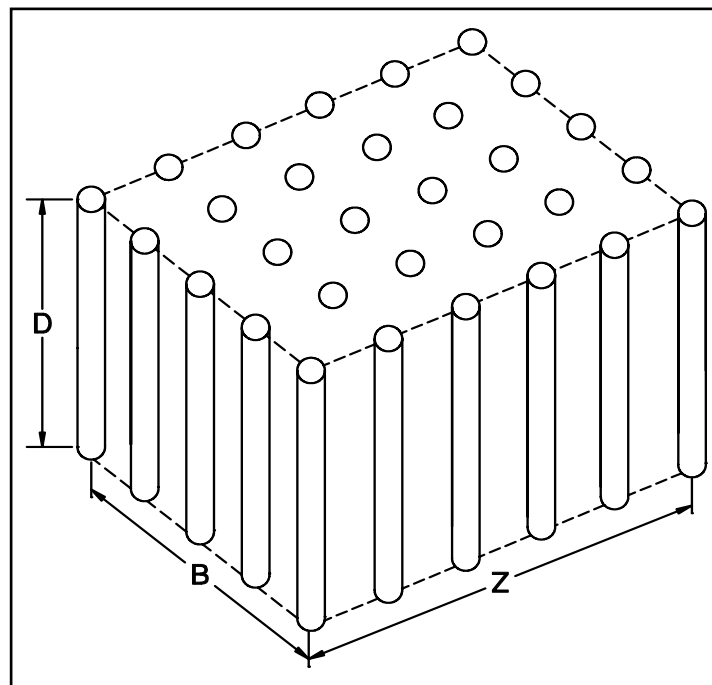

**Figure 9-34. Three dimensional pile group configuration (after Tomlinson, 1994).**

If a pile group will experience the full group load shortly after construction, the ultimate group capacity against block failure should be calculated by using the remolded or a reduced shear strength rather than the average undrained shear strength for  $c_{ul}$ .

The bearing capacity factor,  $N_c$ , for a rectangular pile group is generally 9. However, for pile groups with relatively small pile embedment depths and/or relatively large widths,  $N_c$  should be calculated from the following equation where the terms  $D$ ,  $B$  and  $Z$  are as shown in Figure 9-34.

$$N_c = 5 \left( 1 + \frac{D}{5B} \right) \left( 1 + \frac{B}{5Z} \right) \leq 9 \quad 9-19$$

In the evaluation of possible block failure of pile groups in cohesionless soils underlain by a weak cohesive deposit, the weighted average unit shaft resistance for the cohesionless soils should be substituted for  $c_{ul}$  in calculating the ultimate group capacity. The pile group base strength determined from the second part of the ultimate group capacity equation should be calculated by using the strength of the underlying weaker layer.

## 9.6.2 Settlement of Pile Groups

Pile groups supported in and underlain by cohesionless soils will produce only elastic or immediate settlements. This means that the settlements will occur almost immediately as the pile group is loaded. Pile groups supported in and underlain by cohesive soils may produce both elastic settlements that will occur almost immediately and consolidation settlements that will occur over a period of time. In highly over-consolidated clays, the majority of the foundation settlement will occur almost immediately. Consolidation settlements will generally be the major source of foundation settlement in normally consolidated clays.

Methods for estimating settlement of pile groups are provided in the following sections. Methods for estimating single pile settlements are not provided in this document because piles are usually installed in groups.

### 9.6.2.1 Elastic Compression of Piles

The methods for computing pile group settlement discussed in the following sections consider soil settlements only and do not include the settlement caused by elastic compression of pile material due to the imposed axial load. Therefore, the elastic compression should also be computed and added to the group settlement estimates of soil settlement to obtain the total settlement. The elastic compression can be computed by the following expression:

$$\Delta = \frac{Q_a L}{A E} \quad 9-20$$

where:  $\Delta$  = elastic compression of pile material in inches (mm)  
 $Q_a$  = design axial load in pile in kips (kN)  
 $L$  = length of pile in inches (mm)  
 $A$  = pile cross sectional area in in<sup>2</sup> (mm<sup>2</sup>)  
 $E$  = modulus of elasticity of pile material in ksi (kPa)

The modulus of elasticity for steel piles is 30,000 ksi (207,000 MPa). For concrete piles, the modulus of elasticity varies with concrete compressive strength and is generally on the order of 4,000 psi (27,800 MPa). The elastic compression of short piles is relatively small and can often be neglected in design.

### 9.6.2.2 Settlement of Pile Groups in Cohesionless Soils

Meyerhof (1976) recommended the settlement of a pile group in a homogeneous sand deposit not underlain by a compressible soil be conservatively estimated by the following expressions in U.S. units:

$$s = \frac{4 p_f \sqrt{B} I_f}{\bar{N}'} \quad \text{For silty sand, use: } s = \frac{8 p_f \sqrt{B} I_f}{\bar{N}'} \quad 9-21$$

where:  $s$  = estimated total settlement in inches  
 $p_f$  = design foundation pressure in ksf = group design load divided by group area  
 $B$  = width of pile group in ft  
 $\bar{N}'$  = average corrected SPT  $N_{160}$  value within a depth  $B$  below pile toe  
 $I_f$  = influence factor for group embedment =  $1 - [D / 8B] \geq 0.5$   
 $D$  = pile embedment depth in ft

### 9.6.2.3 Settlement of Pile Groups in Cohesive Soils

Terzaghi and Peck (1967) proposed that pile group settlements could be evaluated using an equivalent footing situated at a depth of  $D/3$  above the pile toe. This concept is illustrated in Figure 9-35. For a pile group consisting of only vertical piles, the equivalent footing has a plan area  $(B)(Z)$  that corresponds to the perimeter dimensions of the pile group as shown in Figure 9-34. The pile group load over this plan area is then the bearing pressure transferred to the soil through the equivalent footing. The load is assumed to spread within the frustum of a pyramid of side slopes at  $30^\circ$  and to cause uniform additional vertical pressure at lower levels. The pressure at any level is equal to the load carried by the group divided by the plan area of the base of the frustum at that level. Once the equivalent footing dimensions have been established then the settlement of the pile group can be estimated by using the procedures described in Chapter 8 (Shallow Foundations).

Rather than fixing the equivalent footing at a depth of  $D/3$  above the pile toe for all soil conditions, the depth of the equivalent footing should be adjusted based upon soil stratigraphy and load transfer mechanism to the soil. Figure 9-36 presents the recommended location of the equivalent footing for the following load transfer and soil resistance conditions:

- a) toe bearing piles in hard clay or sand underlain by soft clay
- b) piles supported by shaft resistance in clay
- c) piles supported in shaft resistance in sand underlain by clay
- d) piles supported by shaft and toe resistance in layered soil profile

Note that Figures 9-35 and 9-36 assume that the pile group consists only of vertical piles. If a group of piles contains battered piles, then they should be included in the determination of the equivalent footing width only if the stress zones from the battered piles overlap with those from the vertical piles.

## 9.7 DESIGN OF PILES FOR LATERAL LOAD

The interaction of a pile-soil system subjected to lateral load has long been recognized as a complex function of nonlinear response characteristics of both pile and soil. The theory and design method for analyzing laterally loaded piles is beyond the scope of this document. Guidance on lateral load analysis is provided in FHWA (1994). The program LPILE is commonly used to evaluate the behavior of single piles under lateral loads. FHWA (2006a) discusses the use of LPILE program for piles subjected to lateral loads.

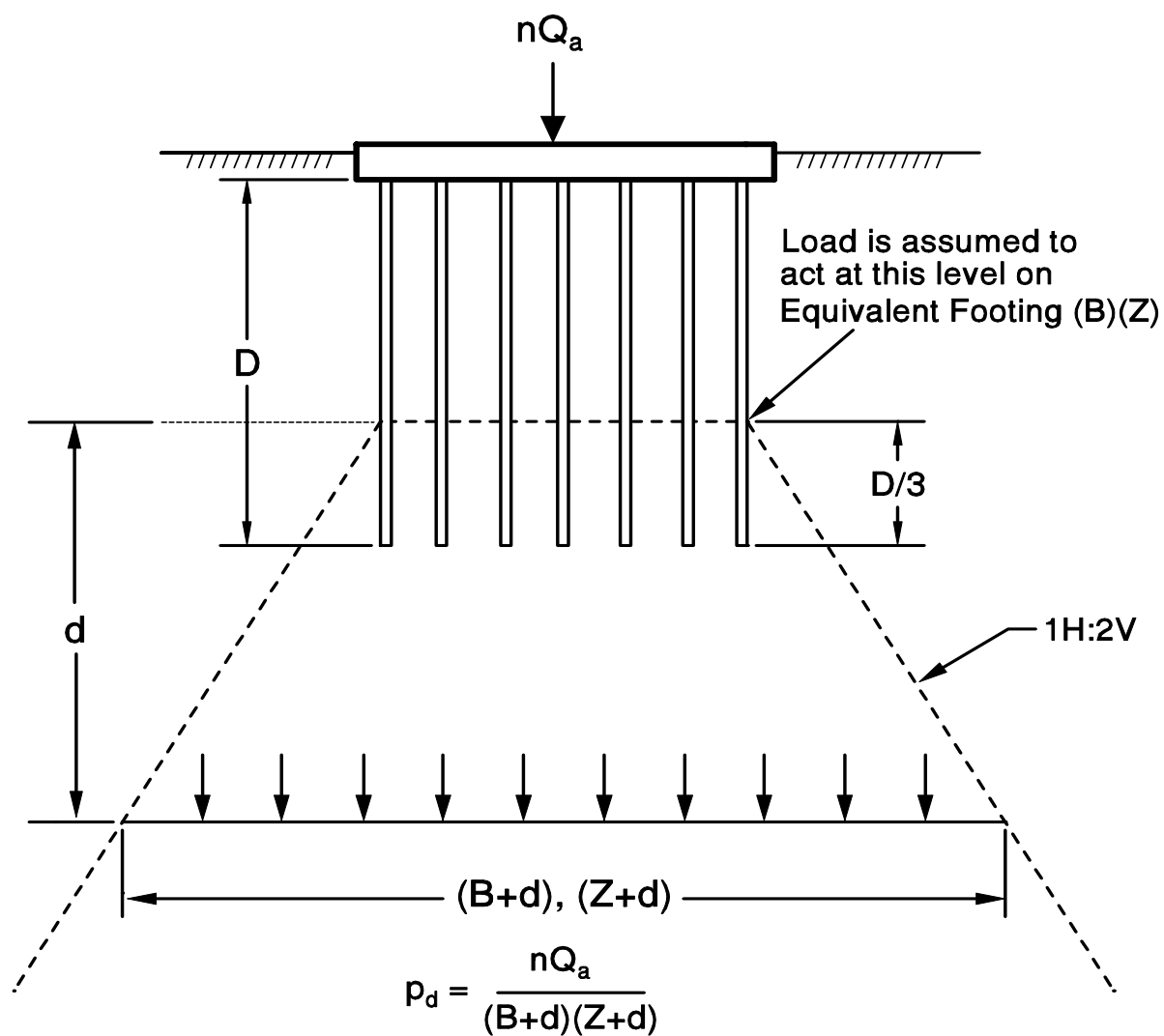

Note: Pile Group has Plan Dimension of B and Z

Figure 9-35. Equivalent footing concept (after Duncan and Buchignani, 1976).



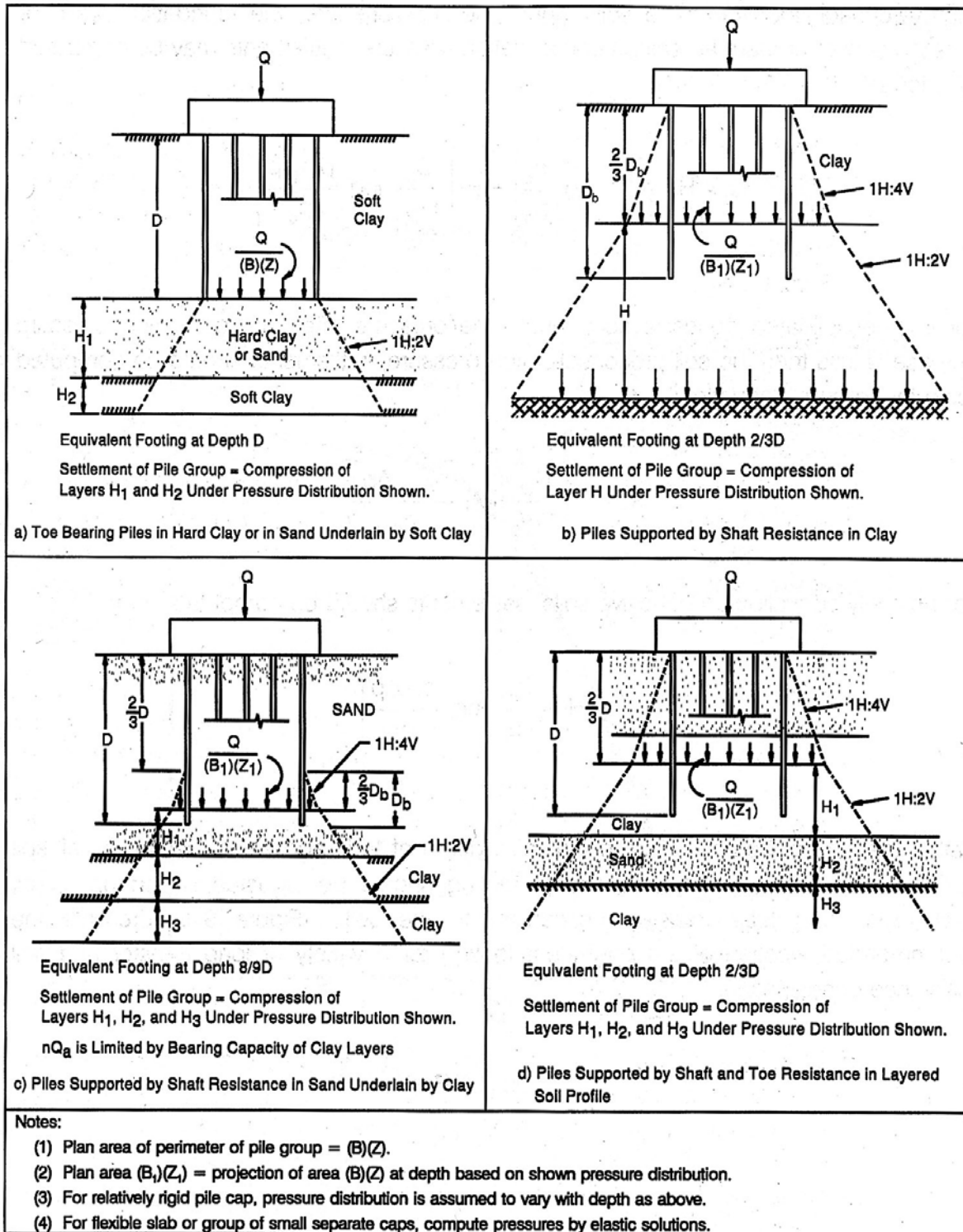

Figure 9-36. Stress distribution below equivalent footing for pile group (FHWA, 2006a).

## 9.8 DOWNDRAG OR NEGATIVE SHAFT RESISTANCE

When piles are installed through a soil deposit undergoing consolidation, the resulting relative downward movement of the soil around piles induces "**downdrag**" forces on the piles. These "downdrag" force is also called negative shaft resistance. Negative shaft resistance is the reverse of the usual positive shaft resistance developed along the pile surface that allows the soil to support the applied axial load. The downdrag force increases the axial load on the pile and can be especially significant on long piles driven through compressible soils. Therefore, the potential for negative shaft resistance must be considered in pile design. Batter piles should be avoided in soil conditions where relatively large soil settlements are expected because of the additional bending forces imposed on the piles, which can result in pile deformation and damage.

Settlement computations should be performed to determine the amount of settlement the soil surrounding the piles is expected to undergo after the piles are installed. The amount of relative settlement between soil and pile that is necessary to mobilize negative shaft resistance is about 0.4 to 0.5 inches (10 to 12 mm). At that amount of movement, the maximum value of negative shaft resistance is equal to the soil-pile adhesion. The negative shaft resistance can not exceed this value because slip of the soil along the pile shaft occurs at this value. It is particularly important in the design of friction piles to determine the depth at which the pile will be unaffected by negative shaft resistance. Only below that depth can positive shaft resistance provide support to resist vertical loads.

The most common situation where large negative shaft resistance develops occurs when fill is placed over a compressible layer immediately prior to, or shortly after piles are driven. This condition is shown in Figure 9-37(a). Negative shaft resistance can also develop whenever the effective overburden pressure is increased on a compressible layer through which a pile is driven as for example in the case of lowering of the ground water table as illustrated in Figure 9-37(b).

NCHRP (1993) presents the following criteria for identifying when negative shaft resistance may occur. If any one of these criteria is met, negative shaft resistance should be considered in the design. The criteria are:

1. The total settlement of the ground surface will be larger than 4 in (100 mm).
2. The settlement of the ground surface after the piles are driven will be larger than 0.4 in (10 mm).

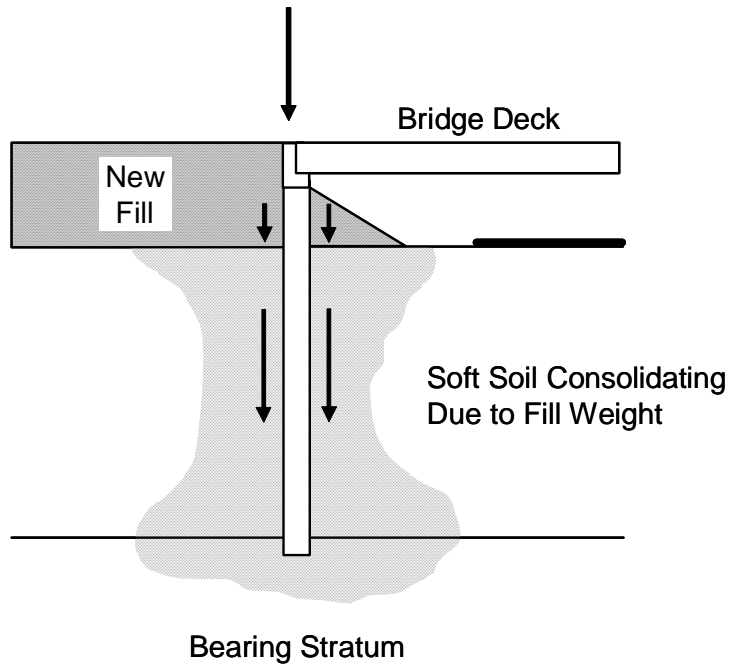

**Figure 9-37(a). Common downdrag situation due to fill weight (FHWA, 2006a).**

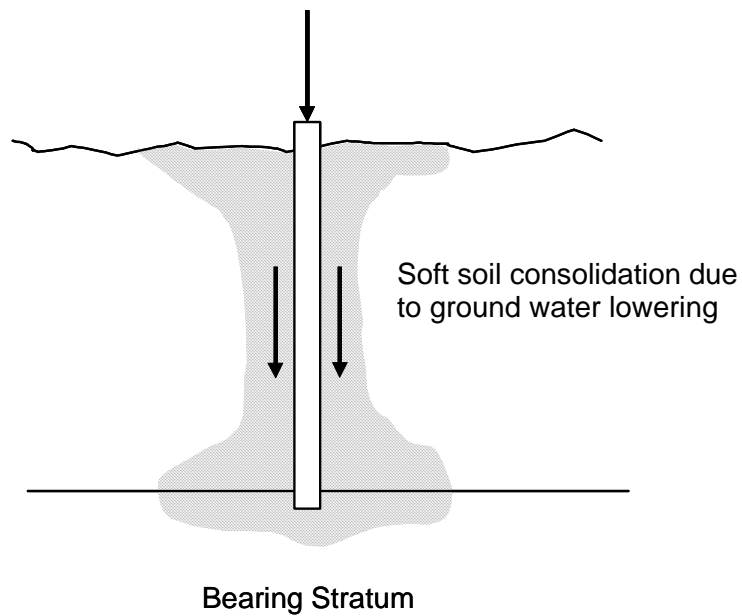

**Figure 9-37(b). Common downdrag situation due to ground water lowering (FHWA, 2006a).**

3. The height of the embankment to be placed on the ground surface exceeds 6.5 ft (2 m).
4. The thickness of the soft compressible layer is larger than 30 ft (10 m).
5. The water table will be lowered by more than 13 ft (4 m).
6. The piles will be longer than 80 ft (25 m).

For pile groups, the total downdrag load should not be calculated by summation of the downdrag load on each pile in the group. Rather, the downdrag load should be computed based on the perimeter surface area of the group block.

FHWA (2006a) presents several different methods for determining negative shaft resistance. In situations where the negative shaft resistance on piles is relatively large such that a reduction in the pile design load is impractical, negative shaft resistance forces can be handled or reduced by using one or more of the following techniques:

- Reduce soil settlement, e.g. by preloading the soil
- Use lightweight fill material
- Use a friction reducer such as bitumen and plastic wrap. These reducers are prone to being scrapped off during driving and are not considered to be reliable.
- Increase allowable pile-stress
- Prevent direct contact between soil and pile, e.g., pile sleeves

The above options for reducing negative shaft resistance are discussed in FHWA (2006a).

## 9.9 CONSTRUCTION OF PILE FOUNDATIONS

Construction control of pile operations is a much more difficult proposition than for spread footings. During footing placement an inspector can easily examine a prepared footing area and observe the concrete footing being poured to assure a quality foundation. Piles derive their support below ground. Direct quality control of the finished product is not possible. Therefore, substantial control must be maintained over the peripheral operations leading to the incorporation of the pile into the foundation. In general terms, control is exercised in two areas; the pile material, and the installation equipment. These items are interrelated since changes in one may affect the others. It is mandatory that pile foundation installation be considered during design to insure that the piles shown on the plans can be installed. This section discusses the installation and construction monitoring aspects of driven pile foundations.

### 9.9.1 Selection of Design Safety Factor Based on Construction Control

The topic of selection of a suitable design safety factor based on construction control was discussed in Section 9.4. It is reiterated that the factor of safety used should be based on the construction control method used for capacity verification. **The factor of safety applied to the design load should increase with the increasing unreliability of the method used for determining ultimate pile capacity during construction.** The recommended factors of safety on the design load for various construction control methods were presented in Table 9-5. The factor of safety for other test methods not included in Table 9-5 should be determined by the individual designer.

### 9.9.2 Pile Driveability

Greater pile penetration depths are increasingly being required to satisfy performance criteria in special design events such as scour, vessel impact, ice and debris loading, and seismic events. Therefore, the ability of a pile to be driven to the required depth has become increasingly more important and must be evaluated in the design stage. **Pile driveability refers to the ability of a pile to be driven to a desired depth and/or capacity.** All of the previously described static analysis methods are meaningless if the pile cannot be driven to the required design depth without sustaining damage. **The limit of pile driveability is the maximum soil resistance a pile can be driven either without sustaining damage or a refusal driving resistance with a properly sized driving system.**

Primary factors controlling the ultimate geotechnical capacity of a pile are the **pile details** (type and length), **subsurface data**, and the method of **installation**. Table 9-9 highlights these factors

and the items to be included in the plans and specifications that are the design engineer's responsibility. Also included in Table 9-9 are the items to be checked for quality assurance that are the construction engineer's responsibility. Since the pile type, length and method of installation can be specified, it is often erroneously assumed that the pile can be installed as designed to the estimated depth. However, the pile must have sufficient driveability to overcome the soil resistance encountered during driving in order to reach the estimated or specified depth. If a pile section does not have a driveability limit in excess of the soil resistance to be overcome during driving, it will not be driveable to the desired depth. **The failure to evaluate pile driveability is one of the most common deficiencies in driven pile design practice.**

In evaluating the driveability of a pile, the soil disturbance during installation and the time dependent soil strength changes should be considered. Both soil setup and relaxation have been described earlier in this chapter. For economical pile design, the foundation designer must match the soil resistance to be overcome at the time of driving with the pile impedance, the pile material strength, and the pile driving equipment. These factors are discussed in the following section.

### 9.9.2.1 Factors Affecting Driveability

A pile must satisfy two aspects of driveability. First, the pile must have sufficient stiffness to transmit driving forces large enough to overcome soil resistance. Second, the pile must have sufficient structural strength to withstand the driving forces without damage.

The primary controlling factor on pile driveability is the pile impedance, which is defined as  $EA/C$ , where  $E$  is the elastic modulus of pile material,  $A$  is the cross-sectional area of the pile and  $C$  is the wave propagation velocity of pile material. Since  $E$  and  $C$  are constant for a given type of pile, only increasing the pile cross sectional area,  $A$ , will improve the pile driveability. For steel H-piles, the designer can improve pile driveability by increasing the H-pile section without increasing the H-pile size. The driveability of steel pipe piles can be improved by increasing the pipe wall thickness. For open ended pipe piles, an inside-fitting cutting shoe can improve driveability by delaying the formation of a soil plug and thereby reducing the soil resistance to be overcome. Most concrete piles are solid cross sections. Therefore, increasing the pile area to improve driveability is usually accompanied by an increase in the soil resistance to driving.

**Table 9-9. Responsibilities of design and construction engineers**

<b>Item</b>	<b>Design Engineer's Responsibilities</b>	<b>Construction Engineer's Responsibilities</b>
Pile Details	Include in plans and specifications: <ol style="list-style-type: none"> <li>a. Material and strength: concrete, steel, or timber.</li> <li>b. Cross section: diameter, tapered or straight, and wall thickness.</li> <li>c. Special coatings for corrosion or downdrag.</li> <li>d. Splices, toe protection, etc.</li> <li>e. Estimated pile tip elevation.</li> <li>f. Estimated pile length.</li> <li>g. Pile design load and ultimate capacity.</li> <li>h. Allowable driving stresses.</li> </ol>	Quality control testing or certification of materials.
Subsurface Data	Include in plans and specifications: <ol style="list-style-type: none"> <li>a. Subsurface profile.</li> <li>b. Soil resistance to be overcome to reach estimated length.</li> <li>c. Minimum pile penetration requirements.</li> <li>d. Special notes: boulders, artesian pressure, buried obstructions, time delays for embankment fills, etc.</li> </ol>	Report major discrepancies in soil profile to the designer.
Installation	Include in plans and specifications: <ol style="list-style-type: none"> <li>a. Method of hammer approval.</li> <li>b. Method of determining ultimate pile capacity.</li> <li>c. Compression, tension, and lateral load test requirements (as needed) including specification for tests and the method of interpretation of test results.</li> <li>d. Dynamic testing requirements (as needed).</li> <li>f. Limitations on vibrations, noise, and head room.</li> <li>g. Special notes: spudding, predrilling, jetting, set-up period, etc.</li> </ol>	<ol style="list-style-type: none"> <li>a. Confirm that the hammer and driving system components agree with the contractor's approved submittal.</li> <li>b. Confirm that the hammer is maintained in good working order and the hammer and pile cushions are replaced regularly.</li> <li>c. Determination of the final pile length from driving resistance, estimated lengths and subsurface conditions.</li> <li>d. Pile driving stress control.</li> <li>e. Conduct pile load tests.</li> <li>f. Documentation of field operations.</li> <li>g. Ensure quality control of pile splices, coatings, alignment and driving equipment.</li> </ol>

A lesser factor influencing pile driveability is the pile material strength. The influence of pile material strength on driveability is limited, since strength does not alter the pile impedance. However, a pile with a higher pile material strength can tolerate higher driving stresses that may allow a larger pile hammer to be used. Use of larger hammer may allow a slightly higher capacity to be obtained before driving refusal or pile damage occurs.

Other factors that may affect pile driveability include the characteristics of the driving system such as ram weight, stroke, and speed, as well as the actual system performance in the field. The dynamic soil response can also affect pile driveability. Soils may have higher damping characteristics or elasticity than assumed, both of which can reduce pile driveability. These factors are discussed in Section 9.9.3 and 9.9.6.

Even if the pile structural capacity and geotechnical capacity both indicate a high pile capacity could be used, a high pile capacity may still not be obtainable because driving stresses may exceed allowable driving stress limits. A pile cannot be driven to an ultimate static capacity that is as high as the structural capacity of the pile because of the additional dynamic resistance or damping forces generated during pile driving. The allowable static design stresses in pile materials specified by various codes generally represent the static stress levels that can be consistently developed with normal pile driving equipment and methods. Maximum allowable design and driving stresses are presented in Section 9.9.7.

### **9.9.2.2 Driveability Versus Pile Type**

Driveability should be checked during the design stage of all driven piles. It is particularly important for closed end steel pipe piles where the impedance of the steel casing may limit pile driveability. Although the designer may attempt to specify a thin-wall pipe without mandrel in order to save material cost, a thin wall pile may lack the driveability to develop the required ultimate capacity or to achieve the necessary pile penetration depth. Wave equation analyses should be performed in the design stage to select the pile section and wall thickness.

Steel H-piles and open-end pipe piles, prestressed concrete piles, and timber piles are also subject to driveability limitations. This is particularly true as allowable design stresses increase and as special design events such as scour require increased pile penetration depths. The driveability of long prestressed concrete piles can be limited by the pile's tensile strength.

The following sections discuss the various aspects related to pile driveability. First, the pile driving equipment and operation (Section 9.9.3) is introduced followed by the fundamental pile driving formula (Section 9.9.4), basics of the dynamic analysis of pile driving (Section 9.9.5),



use of wave equation methodology to perform dynamic analysis of pile driving (Section 9.9.6), discussion of driving stresses (Section 9.9.7), and some useful guidelines to assess the results of wave equation analysis in terms of pile driveability (Section 9.9.8). General pile construction monitoring considerations are discussed in Section 9.9.10 followed by a brief description of the elements of dynamic pile monitoring in Section 9.9.11.

### 9.9.3 Pile Driving Equipment and Operation

Proper inspection of pile driving operations requires that the inspector have a basic understanding of pile driving equipment. Estimation of "as driven pile capacity" is usually based on the number of hammer blows needed to advance the pile a given distance. Each hammer blow transmits a given amount of energy to the pile. The total number of blows is the total energy required to move the pile a given distance. This energy can then be related to soil resistance and supporting capacity. However, pile inspection entails more than counting blows of the hammer.

The energy transmitted to the pile by a given hammer can vary greatly depending on the equipment used by the contractor. Energy losses can occur by poor alignment of the driving system, improper or excessive cushion material, improper appurtenances, or a host of other reasons. As the energy losses increase, additional blows are required to move the pile. The manufacturer's rated hammer energy is based on minimal energy losses. Assumptions that the hammer is delivering its rated energy to the pile can prove dangerous if substantial energy is lost in the driving system. Artificially high blow counts can result in acceptance of driven pile lengths, which are shorter than that necessary for the required pile capacity.

Important elements of the driving system include the **leads**, the **hammer cushion**, the **helmet**, and for concrete piles, the **pile cushion**. Typical components of a pile driving system are shown in Figure 9-38. The leads are used to align the hammer and the pile such that every hammer blow is delivered concentrically to the pile system. The helmet holds the top of the pile in proper alignment and prevents rotation of the pile during driving. Typical components of a helmet are shown in Figure 9-39. The hammer and the helmet "ride" in the leads so that hammer - pile alignment is assured.

All impact pile driving equipment, except some gravity hammers should be equipped with a suitable thickness of hammer cushion material. The function of the hammer cushion is to prevent damage to the hammer or pile and insure uniform energy delivery per blow to the pile. Hammer cushions must be made of durable manufactured materials provided in accordance with the hammer manufacturer's guidelines. All wood, wire rope and asbestos hammer cushions are

specifically disallowed and should not be used. The thicker the hammer cushion, the less the amount of energy transferred to the pile. Mandatory use of a durable hammer cushion material, which will retain uniform properties during driving, is necessary to relate blow count to pile capacity accurately. Non-durable materials, which deteriorate during driving, cause erratic energy delivery to the pile and prevent the use of blow counts to determine pile capacity.

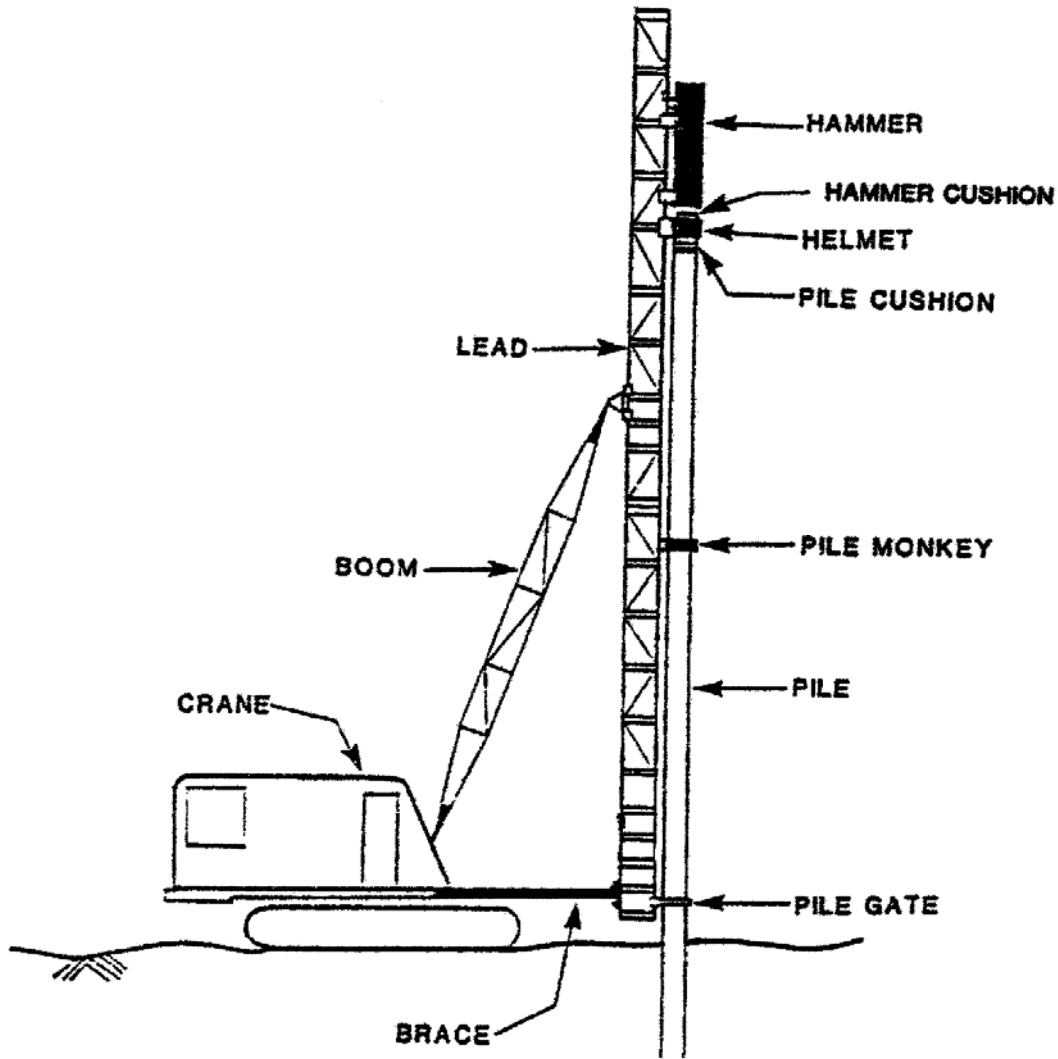
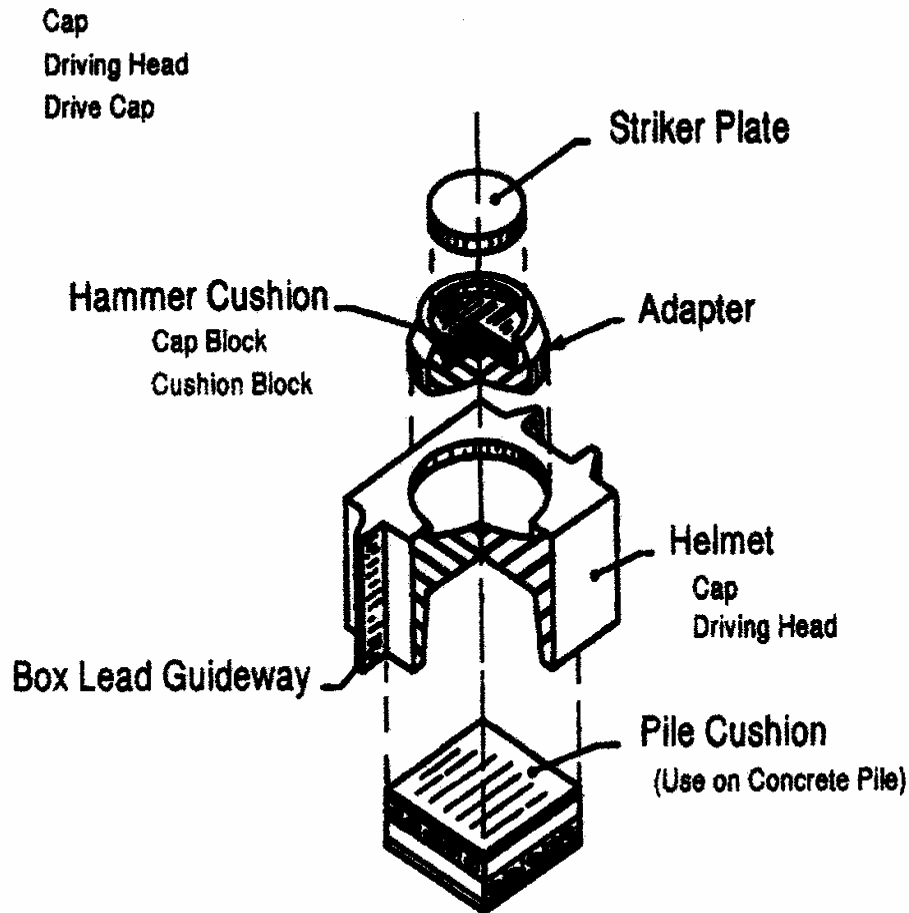

Figure 9-38. Typical components of a pile driving system.

## Helmet (Complete Unit)



Note: The helmet shown is for nomenclature only. Various sizes and types are available to drive H, pipe, concrete (shown) and timber piles. A system of inserts or adapters is utilized up inside of the helmet to change from size to size and shape to shape.

**Figure 9-39. Typical components of a helmet.**

The heads of concrete piles must be protected by a pile cushion made of hardwood or plywood. The minimum thickness of pile cushion placed on the pile head should not be less than four inches. A new pile cushion should be provided for each pile.

A non-routine element called a **follower** may be used in the driving system, particularly for piles driven below water. Followers cause substantial and erratic reduction in the hammer energy transmitted to the pile due to the follower is flexibility, poor connection to the pile head, frequent misalignment, etc. Reliable correlation of blow count with pile capacity is impossible when followers are used. Special monitoring with devices such as the Pile Driving Analyzer (PDA) (FHWA, 2006a) should be specified when followers are used.

#### 9.9.4 Dynamic Pile Driving Formulae

In the 1800s, the fundamental pile driving formula was established to relate dynamic driving forces to available pile bearing capacity. The formula was based on a simple energy balance between the kinetic energy of the ram at impact and the resulting work done on the soil, i.e., a distance of pile penetration against a soil resistance. The concept assumed a pure Newtonian impact with no energy loss. The fundamental formula was expressed as follows:

WORK DONE ON SOIL = KINETIC ENERGY INPUT

$$RS = WH = 12 E_n \quad 9-22$$

where: W = weight of the ram in pounds  
H = distance of ram fall in feet  
R = total soil resistance against the pile (driving capacity) in pounds  
S = pile penetration per blow (set) in inches  
E<sub>n</sub> = driving energy (ft-lbs), which is converted to in-lbs for unit consistency by multiplying by 12.

An inherent difficulty in the pile driving operation is that only a portion of the ram's kinetic energy actually causes penetration of the pile. Studies indicate that typically only 30 to 65 percent of the rated energy is passed through to the pile. Much of the energy is lost in either heat (soil friction, hammer mechanism, pile material, etc.) or strain (elastic compression of the cushion, the pile and the surrounding soil). For example, if the elastic shortening of the pile ( $\Delta L$ ) is  $RL/AE$ , where  $L$  = the effective length of the pile in inches,  $A$  = the cross sectional area of the pile in  $\text{in}^2$ , and  $E$  = modulus of elasticity of the pile material in  $\text{lbs}/\text{in}^2$ , then the average shortening along the length of the pile would be  $\Delta L/2$  and the energy lost due to elastic compression of the pile would be  $R(\Delta L/2)$  or  $R^2L/2AE$ . Therefore, if all losses are ignored except those due to elastic compression of the pile, then Equation 9-22 can be re-written as:

$$RS = 12 E_n - \frac{R^2L}{2AE} \quad 9-23a$$

If the pile is driven through reasonably uniform soil the effective length,  $L$ , is the full length of pile penetration. If the pile is driven through relatively firm soil into a weaker substratum, the effective length is generally taken as the length from the head of the pile to the depth of the weak substratum.

If  $k$  is defined as  $RL/2AE$  then Equation 9-23a can be re-written as:

$$RS = 12 E_n - Rk \quad 9-23b$$

When Equation 9-23b is solved for total soil resistance ( $R$ ) the result is the Engineering News pile driving formula:

$$R = \frac{12 E_n}{S + k} \quad 9-24$$

The Engineering News (EN) pile driving formula was first published in the *Engineering News* in the year 1888. The EN formula is commonly, but incorrectly termed the ENR formula since the publishers of the *Engineering News* merged with the McGraw-Hill Publishing Company in 1917 to produce the *Engineering News-Record*. The EN formula was developed for wood piles driven by a drop hammer. As expressed by Equation 9-24, the EN formula is for driving resistance. Subsequently, in an attempt to develop a relationship between driving resistance and bearing capacity, the equation was modified to provide the safe load that a pile could withstand to the input energy and set per blow. The basic assumption in the modification of the original EN formula is that the safe working load ( $P$ ) is one-sixth of the driving resistance. Therefore, the basic EN formula as we know it today is:

$$P = \frac{R}{6} = \frac{2E_n}{S + k} \quad 9-25$$

where:

- $E_n$  = driving energy (ft-lbs).
- $S$  = pile penetration per blow (set) in inches.
- $k$  = constant based on hammer type = 0.1 for single acting steam hammer and 1 for drop hammer.

According to Hough (1957), the basic assumption that the safe working load ( $P$ ) is one-sixth of the driving resistance is not the same as applying a factor of safety of 6 to the ultimate bearing capacity under static load. The real factor of safety for the EN formula may be considerably more or even less than 6 under certain conditions

Most engineers are not aware (1) that the EN formula was originally developed for timber piles, or (2) that the EN formula has a built-in factor of safety of 6. Sowers (1979) states the following about the EN formula:

"The EN formula was derived from observations of the driving of wood piles in sand with free-falling drop hammers. Numerous pile load tests show that the real factor of safety of the formula can be as low as 2/3 and as high as 20. For wood piles driven with free-falling drop hammers and for lightly loaded short piles driven with a steam hammer, the EN formulas give a crude indication of pile capacity. For other conditions they can be very misleading."

In 1988 the Washington State DOT published a study (WSDOT, 1988) based on high quality pile load test data that showed the EN formula to be the least reliable of the 10 dynamic formulae that were analyzed. Subsequent studies by FHWA as part of the Demonstration Project 66 (precursor of the FHWA (2006a) manual) confirmed the unreliability of the EN formula, particularly for higher pile loads where actual safety factors are too frequently less than 1.0.

The WSDOT and FHWA studies resulted in both organizations replacing EN in their specifications with the Gates dynamic formula. However, the Gates dynamic formula, which was originally developed based on correlations with static load test data, is usually restricted to piles that have driving capacities less than 600 kips. The Gates formula, was modified by FHWA for driving capacity as shown below:

$$R_u = 1.75 \sqrt{E_r} \log_{10}(10N_b) - 100 \quad 9-26a$$

where:  $R_u$  = the ultimate pile capacity (kips)

$E_r$  = the manufacturer's rated hammer energy (ft-lbs) at the **field observed ram stroke**

$N_b$  = the number of hammer blows per 1 inch at final penetration

The number of hammer blows per foot of pile penetration required to obtain the ultimate pile capacity is calculated as follows:

$$N/ft = 12 (10^x) \quad 9-26b$$

where:  $x = [(R_u + 100)/(1.75 \sqrt{E_r})] - 1$

### 9.9.5 Dynamic Analysis of Pile Driving

An examination of the pile driving process discloses that the concept of a Newtonian impact does not apply. When viewed in slow motion, the ram does not immediately rebound from the pile after impact. The ram transfers force to the pile head over a finite period of time that depends on the properties of the hammer-pile-soil system. A force pulse is created that travels down the pile in a **wave** shape. The amplitude of the wave will decay due to system damping properties before reaching the pile tip. The force in the wave, which reaches the tip, will "pull" the pile tip into the soil before the wave is reflected back up the pile. After reflection, an amount of permanent "set" of the pile tip will remain. This process is crudely shown in Figure 9-40 for the hammer-pile-soil system.

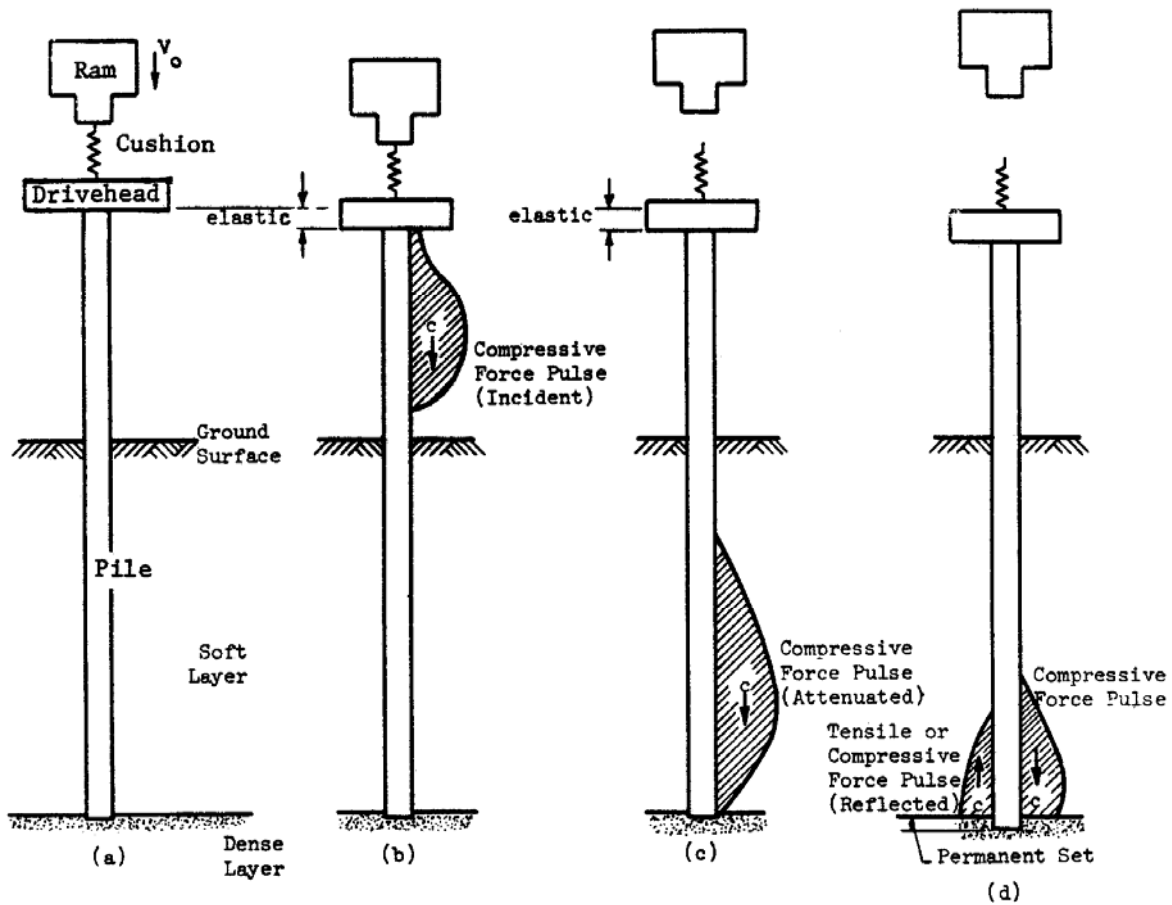

Figure 9-40. Hammer-pile-soil system.

The analysis of the force pulse wave is commonly known as the **wave equation analysis** (WEA). In a WEA a number of variables such as pile length and flexibility are accounted for in addition to the variations in the contractor's driving system and the project soils. Therefore, WEA represents a significant improvement over dynamic formulas. The approach was developed by E.A.L. Smith (1960), and after the rationality of the approach had been recognized, several researchers developed a number of computer programs. For example, the Texas Department of Highways supported research at the Texas Transportation Institute (TTI) in an attempt to determine driving stresses and reduce concrete pile damage by using a realistic analysis method. FHWA sponsored the development of both the TTI program (Hirsch, *et al.*, 1976) and WEAP (Goble and Rausche, 1976). FHWA supported the development of WEAP to obtain analysis results backed by measurements taken on construction piles during installation for a variety of hammer models. WEAP was updated several times under FHWA sponsorship until 1986 (Goble and Rausche, 1986). Later, additional options, improved data files, refined mathematical representations and modern user conveniences were added to this program on a proprietary basis, and the program is now known as GRLWEAP (Pile Dynamics, Inc. 2005). TNOWAVE is a similar program developed in the Netherlands since 1970s and is popular in Europe and elsewhere. Similar computer programs based on the method of characteristics have been developed such as PDPWAVE (Bielefeld and Middendorp, 1992).

The wave equation approach has been subjected to a number of checks and correlation studies. Studies on the performance of WEAP have produced publications demonstrating that program's performance and utility (e.g., Blendy 1979, Soares, *et al.* 1984, Rausche, *et al.*, 2004). In the WEA approach, it is recognized that each element in the hammer-pile-soil system affects the pile penetration and stresses caused in the pile. A few characteristics of each element are discussed below before the WEA methodology is discussed in detail.

## **1. Hammer**

- Pile hammers can be categorized into two main types: impact hammers and vibratory hammers. There are numerous types of impact hammers having variations in the types of power source, configurations, and rated energies.
- Mechanical efficiency determines what percentage of rated energy is transmitted by the ram. Typical values of mechanical efficiency for hammers in good condition are 50% for double or differential acting air hammers, 67% for single acting air/steam hammers, 80% for diesel hammers, and 80 to 95% for hydraulic hammers.



- Force wave shape characteristics are different for different hammer types. The shape affects pile stress and pile penetration.

## **2. Pile and Appurtenances (Cushions, Helmets, etc.)**

- The stiffness of appurtenances such as the hammer cushion is defined by the cross sectional area times the modulus of elasticity divided by the thickness. The stiffness has a major effect on both blow count and stress transfer to the pile. These elements must not degrade during driving as observed blow count will decrease and pile stresses increase.
- As noted in Section 9.9.2.1, pile impedance affects pile driveability. The cross sectional area of the pile does not control pile driveability. As an example, an HP 14x117 has a cross-sectional area of 34.4 in<sup>2</sup> (0.22 m<sup>2</sup>) and an impedance of 61.4 k-s/ft (900 kN-s/m). A 12 in square concrete pile has a cross-sectional area of 144 in<sup>2</sup> (0.93 m<sup>2</sup>) and an impedance of 57.9 k-s/ft (845 kN-s/m). Hence, the H pile has better driveability even though it has approximately 25% of the cross-sectional area of the concrete pile.

## **3. Soil**

- Soil strength may be permanently or temporarily changed during driving. Piles being driven into soil that contains large percentages of fines may require restrikes to estimate long term capacity due to effects of set-up or relaxation.
- The damping properties of the soil surrounding the pile can have a dramatic effect on the observed blow count. An increase in damping decreases driveability. Damping parameters can be estimated by soil type or from basic index test data. Consideration of the dynamic aspects of the field pile driving operation is necessary so that the driving characteristics can be related to the static pile capacity. Foundation designers should routinely consider the potential for dynamic effects such as set-up and include provisions for field observations such as restrikes. In addition, construction control of pile driving should account for basic dynamic parameters that influence blow count and pile stress. Some of these parameters can be controlled by specification; others require use of a pile wave equation analysis.

### 9.9.6 Wave Equation Methodology

The wave equation analysis (WEA) is a tool to understand the variable involved in pile driving. In a WEA, the hammer, helmet, and pile are modeled by a series of segments each consisting of a concentrated mass and a weightless spring. A schematic of the wave equation hammer-pile-soil model is presented in Figure 9-41. The hammer and pile segments are approximately 3 ft in length. Spring stiffness and mass values are calculated from the cross sectional area, modulus of elasticity, and specific weight of the corresponding pile section. Hammer and pile cushions are represented by additional springs whose stiffnesses are calculated from area, modulus of elasticity, and thickness of the cushion materials. In addition, coefficients of restitution (COR) are usually specified to model energy losses in cushion materials and in all segments that can separate from their neighboring segments by a certain slack distance. The COR is equal to unity for a perfectly elastic collision that preserves all energy and is equal to zero for a perfectly plastic condition that loses all deformation energy. The usual condition of partially elastic collisions is modeled with an intermediate COR value.

The soil resistance along the embedded portion of the pile and at the pile toe is represented by both static and dynamic components. Therefore, both a static and a dynamic soil resistance force acts on every embedded pile segment. The static soil resistance forces are modeled by elasto-plastic springs and the dynamic soil resistance by dashpots. The displacement at which the soil changes from elastic to plastic behavior is referred to as the soil "quake,"  $q$ . The dynamic soil resistance is proportional to a damping factor,  $J$ , times the pile velocity times the assigned static soil resistance. The parameters  $q$  and  $J$  are shown in lower left hand corner of Figure 9-41. In simple terms,  $q$ , is a parameter used in determination of static resistance while  $J$  is a parameter used in determination of dynamic resistance.

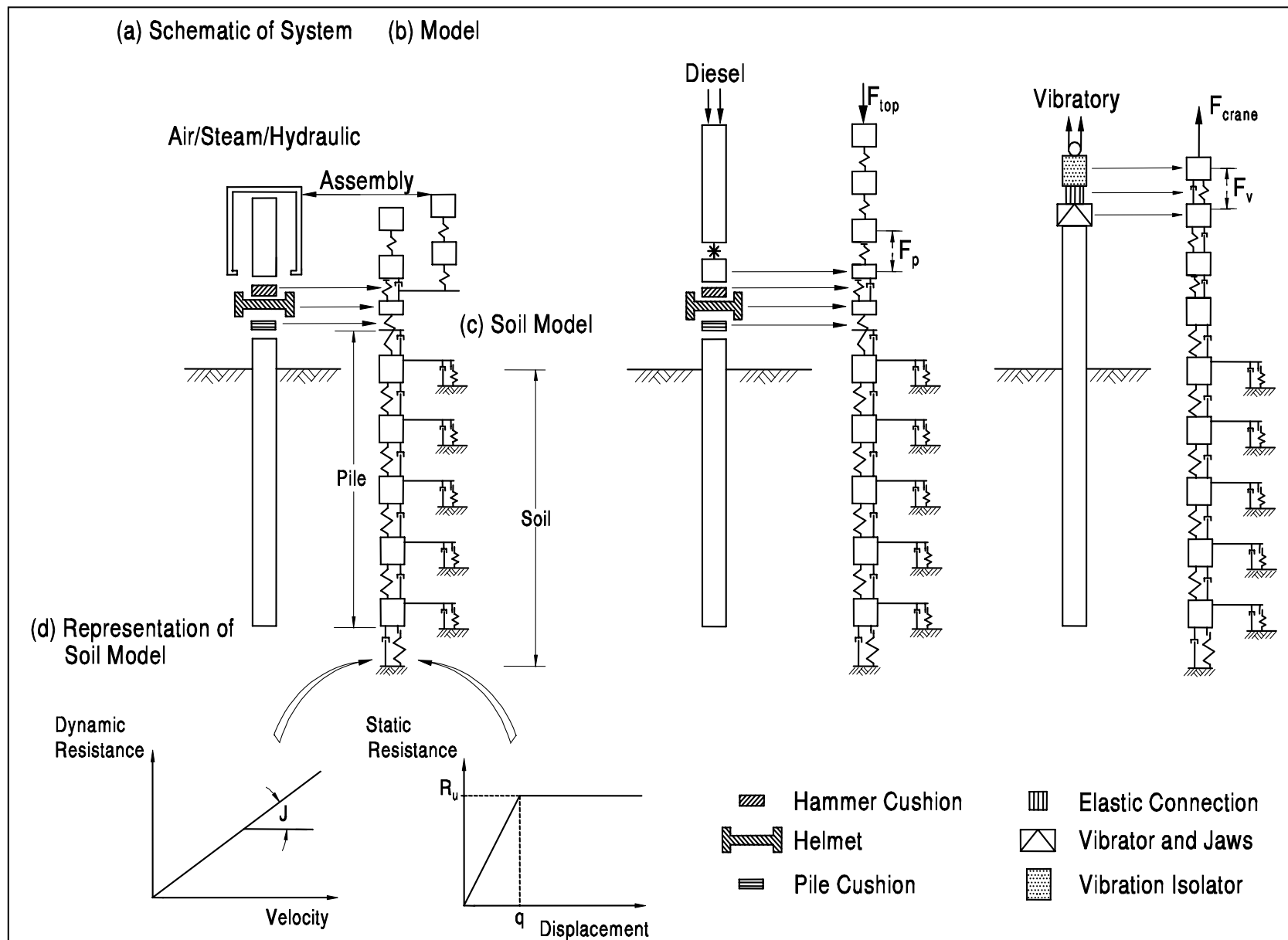

Figure 9-41. Typical Wave Equation models (FHWA 2006a).

### 9.9.6.1 Input to Wave Equation Analysis

In a typical wave equation analysis, parameters defining the hammer, pile (plus appurtenances), and soil systems are needed. The confidence level that can be assigned to the output is directly related to how well the project-specific input parameters are known. The basic input parameters are discussed below.

- **Hammer Data:** Hammer input properties are usually well known from a manufacturers' database. In a driveability analysis, hammer types are selected based on the soil resistance to be overcome. In construction monitoring analysis the contractor submits the intended driving system for review and approval. If a satisfactory driving system is submitted and approved, then the only major concern in construction is that the hammer is in good working condition as was assumed for the input.
- **Driving System or Appurtenance Data:** The driving system or appurtenance data consists of information on hammer cushion, helmet including striker plate, inserts, adapters, etc. and pile cushion in case of concrete piles. The properties of cushions, for both hammer and pile, are especially critical. Only manufactured materials whose properties remain reasonably constant during driving can be used with confidence. The actual cushion thickness used in the field must be checked and discrepancies reported so that the wave equation analysis can be modified.
- **Pile Data:** Required pile data consists of total length, cross-sectional area, elastic modulus and weight, all as a function of depth. This is the pile profile. *The wave analysis cannot predict pile length.* This fact is commonly misunderstood by engineers. Pile length is determined by static analysis procedures and then used as input to pile wave analyses. One exception is a "driveability analysis" where pile behavior is assessed at various depths. The cross sectional area of the pile is frequently varied in design analyses to determine which section is both driveable and cost effective. Increasing the pile section has the effect of improving driveability as well as reducing pile stresses.
- **Soil Data:** Soil data input requires both an understanding of site-specific soil properties and the effects of pile driving on those properties. Dynamic properties such as damping and quake are roughly correlated with soil type. These properties are best determined by experienced geotechnical specialist. The driving soil resistance and its distribution are determined from the static analysis. The driving soil resistance may be substantially greater than the design load times the safety factor; particularly for piles in scour situations. Also the dynamic effects of pile driving on soil resistance must be

considered by an experienced geotechnical specialist to determine set-up or relaxation values for ultimate soil resistance. These dynamic effects are frequently overlooked, which can result in large variations between estimated and actual pile lengths.

### 9.9.6.2 Output Values from Wave Equation Analysis

The results of a wave equation analysis include the predicted blow count, pile stresses, and delivered hammer energy for an assigned driving soil resistance,  $R_{ult}$ , and for given hammer, driving system (appurtenance), pile and soil conditions. **Each wave equation analysis is for the specific pile length that was considered in the analysis.** A summary table of the results obtained from a wave equation analysis is shown in Table 9-10. The data shown in Table 9-10 was generated for a specific site where a pile length of 50 ft (15 m) was being analyzed.

**Table 9-10**  
**Summary of example results from wave equation analysis**

$R_{ult}$ kips	Blow Count BPF	Stroke (EQ) ft	Tensile Stress ksi	Compressive Stress ksi	Transfer Energy ft-kip
35.0	7	3.27	-0.73	1.68	13.6
80.0	16	3.27	-0.32	1.71	13.6
140.0	30	3.27	-0.20	1.73	13.0
160.0	35	3.27	-0.14	1.73	13.0
195.0	49	3.27	-0.00	1.75	12.8
225.0	63	3.27	0.0	1.96	12.7
280.0	119	3.27	0.0	2.34	12.6
350.0	841	3.27	0.0	2.75	12.5

Note that for each driving resistance ( $R_{ult}$ ), a value of blow count, hammer stroke, tensile stress, compressive stress, and transferred energy has been computed. The data is also commonly shown in graphical form as noted in Figure 9-42.

### 9.9.6.3 Pile Wave Equation Analysis Interpretation

The data in Table 9-10, when plotted as shown in Figure 9-42, presents the predicted relationship between pile hammer blow count and other variables for the situation when the pile is embedded 50 ft (15 m) in the ground. The plot, which relates the ultimate capacity to penetration resistance, is known as a **bearing graph**. The data in Table 9-10 is interpreted in the field by comparing them with the measured blow count at a pile penetration of 50 ft (15 m) as follows. When the pile reaches 50 ft (15 m), if the blow count is 49, the driving resistance is 195 kips (867 kN), the stroke is 3.27 ft (0.99 m), the tensile stress is zero ksi, the compressive stress is 1.75 ksi (12,069 kPa), and transferred energy is 12.8 ft-kips (17.3 m-kN). If the blow count had been 63 the driving resistance would have been predicted to be 225 kips (1,000 kN), etc.

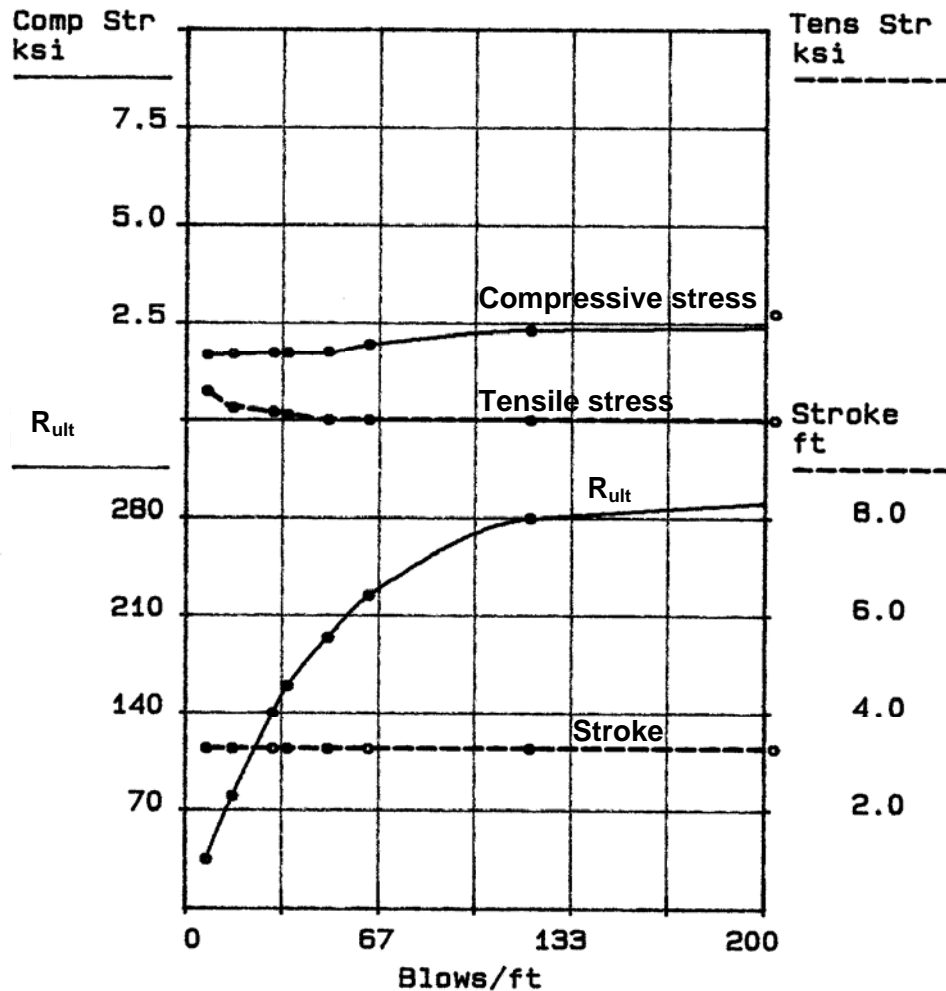

**WAVE EQUATION BEARING GRAPH**

**Figure 9-42. Summary of stroke, compressive stress, tensile stress, and driving capacity vs. blow count (blows/ft) for air-steam hammer.**

Note that Table 9-10 is an example for an air-steam hammer and the stroke is constant for all blow counts. Diesel hammers operate at different strokes depending on the pile-soil properties. A pile wave summary table for a diesel hammer will display a predicted combination of blow count and stroke that is necessary to achieve the driving capacity. In fact, there are numerous combinations of blow count and stroke that correspond to a particular driving resistance. These combinations may be computed and plotted for a selected driving resistance. A typical plot of diesel hammer stroke versus blow count is shown in Figure 9-43 for a constant resistance of 240 kips (1,067 kN).

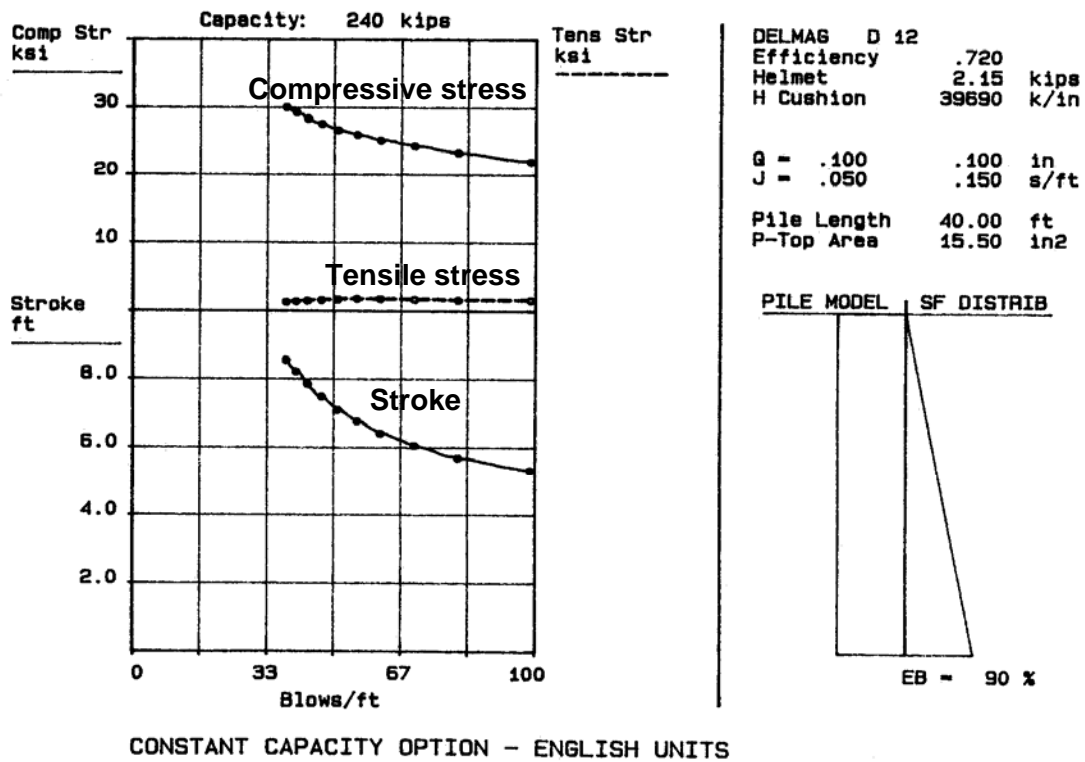

Figure 9-43. Graph of diesel hammer stroke versus blow count for a constant pile capacity.

A wave equation bearing graph is substantially different from a similar graph generated from a dynamic formula. The wave equation bearing graph is associated with a single driving system, hammer stroke, pile type, soil profile, and a particular pile length. If any one of the above items is changed, the bearing graph will also change.

### 9.9.7 Driving Stresses

In almost all cases, the highest stress levels occur in a pile during driving. High driving stresses are necessary to cause pile penetration. The pile must be stressed to overcome the ultimate soil resistance, plus any dynamic resistance forces, in order to be driven to the design depth and load. The high strain rate and temporary nature of the loading during pile driving allow a substantially higher driving stress limitation than for the static design case. Wave equation analyses can be used for predicting driving stresses prior to installation. During installation, dynamic testing can be used to monitor driving stresses.

The stresses predicted by the wave equation analysis should be compared to safe stress levels. This comparison is usually performed for the tensile and compressive stress shown at the computed driving resistance for the estimated pile length. Table 9-11 presents a summary of design and driving stresses for various types of driven piles.

### 9.9.8 Guidelines for Assessing Pile Driveability

The last operation in pile design is to insure that the pile can be driven to the estimated length without damage. For this purpose a trial wave equation analysis is done with an appropriately sized hammer. Figure 9-44 can be used to choose a reasonable hammer for wave analysis. In general, the suggested hammer energies in Figure 9-44 are less than the optimum energy necessary to drive the appropriate pile cross section. Judgment should be used in selecting the hammer size. If initial wave equation analysis yield high blow counts and low stresses the hammer size should be increased.

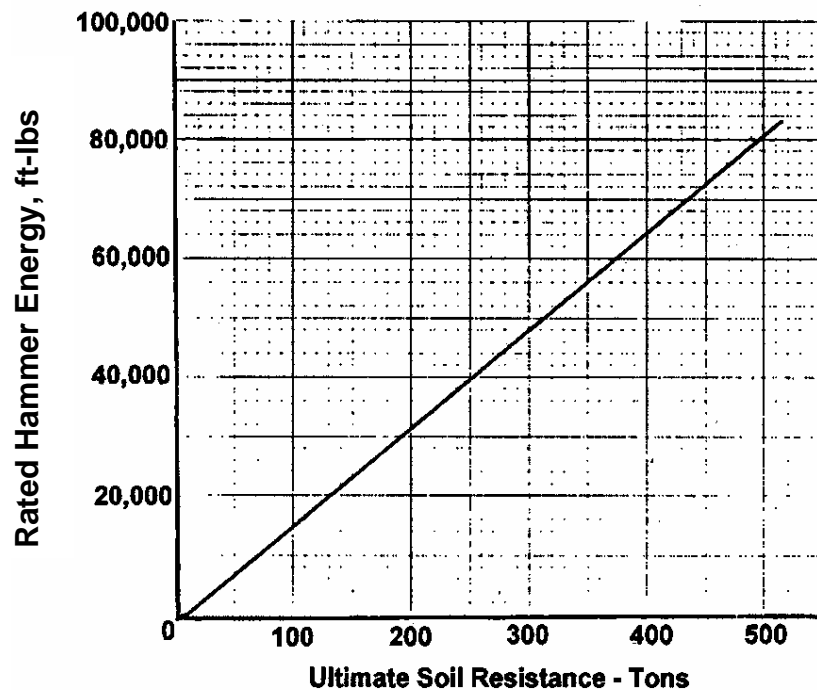

Figure 9-44. Suggested trial hammer energy for wave equation analysis.

During design, a wave equation analysis should be performed to determine if a reasonable range of hammer energies can drive the proposed pile section without exceeding the allowable driving stresses listed in Table 9-11 and a reasonable range of hammer blows, i.e., 30 to 144 bpf for friction piles and higher blows of short duration for end bearing piles. This concept is illustrated numerically by Example 9-4.





**Example 9-4:** Determine if the 14 inch square concrete pile can be driven to a driving capacity of 225 kips by using the wave equation output summary provided. Assume the concrete compressive strength,  $f_c$ , is 4000 psi and the pile prestress,  $f_{pe}$ , is 700 psi.

**Wave equation output summary**

<b>R<sub>ult</sub> kips</b>	<b>Blow Count BPF</b>	<b>Stroke (EQ) ft</b>	<b>Tensile Stress ksi</b>	<b>Compressive Stress ksi</b>	<b>Transfer Energy ft-kip</b>
35.0	7	3.27	-0.73	1.68	13.6
80.0	16	3.27	-0.32	1.71	13.6
140.0	30	3.27	-0.20	1.73	13.0
160.0	35	3.27	-0.14	1.73	13.0
195.0	49	3.27	-0.00	1.75	12.8
225.0	63	3.27	0.0	1.96	12.7
280.0	119	3.27	0.0	2.34	12.6
350.0	841	3.27	0.0	2.75	12.5

**Solution:**

Acceptable driveability depends on achieving the desired driving capacity at hammer blows between 30 and 144 bpf without exceeding the allowable compressive and tensile driving stress.

1. At  $R_{ult} = 225$  kips, blow count = 63 bpf                      O.K.(between 30 and 144)
  
2. The allowable driving stresses based on Table 9-11, for prestressed precast concrete piles are calculated as follows:
  - Compressive stress allowed =  $0.85 f_c - f_{pe} = 0.85 (4,000 \text{ psi}) - 700 \text{ psi} = 2,700 \text{ psi}$ ,
  - Actual maximum compressive stress up to 225 kips from wave equation output summary is 1.96 ksi or 1,960 psi  $\leq 2,700$  psi allowed value.      O.K.
  - Tensile stress allowed =  $3 (f_c)^{1/2} + f_{pe} = 3 (4,000 \text{ psi})^{1/2} + 700 \text{ psi} = 890 \text{ psi}$
  - Actual maximum tensile stress up to 225 kips from wave equation output summary is 0.730 ksi or 730 psi  $\leq 890$  psi allowed value.      O.K.

Therefore, the analyzed pile-hammer system can be approved.

### 9.9.9 Pile Construction Monitoring Considerations

The approval of a contractor's driving equipment is an example of design and construction coordination. It is recommended to use the wave equation analysis to determine if the contractor's equipment is adequate to drive the pile to the estimated length without pile damage. The steps in this procedure are as follows:

1. The pile specifications should include a statement similar to:

"All pile driving equipment to be furnished by the contractor shall be subject to the approval of the engineer. Prerequisite to such approval, the contractor shall submit the following:

- a. A completed pile and driving equipment data form (Figure 9-45) for each hammer proposed for the project.
- b. A wave equation analysis performed by a professional engineer for each proposed hammer at least to the soil resistance value listed on the plans.

Contractor notification of acceptance or rejection of the hammer will be made within 14 days of receipt of the data form and wave equation analysis."

In this case the contractor is charged with performing the wave equation analysis. In some cases, the owner may perform the analysis.

2. The designer should also receive a copy of the data form and the results of wave equation analysis. An independent wave equation analysis should be performed to verify the submitted results and in some cases to establish driving criteria for the piles. The designer should check the results for reasonableness. For example, 30 to 144 blows per foot are considered reasonable for friction piles. Greater blow counts can be permitted for end bearing piles since the duration of high blow counts is short. Then the stresses at that blow count are checked to determine if the values are below the allowable driving stress of the pile material. If these items are satisfied, the equipment can be approved and the information sent to the construction engineer. The results of the wave equation analysis may be transmitted to the field with a recommendation to reject or approve the hammer.
3. The procedure for the changing of approved hammers during the contract is the same.

Contract No.: _____ Project: _____ County: _____	Structure Name and/or No.: _____ Pile Driving Contractor or Subcontractor: _____ _____ (Piles driven by)
--------------------------------------------------------	-------------------------------------------------------------------------------------------------------------------

<b>Hammer Components</b>		<b>Hammer</b> Manufacturer: _____ Model No.: _____ Hammer Type: _____ Serial No.: _____ Manufacturers Maximum Rated Energy: _____ (Joules) (ft-k) Stroke at Maximum Rated Energy: _____ (meters) (ft) Range in Operating Energy: _____ to _____ (Joules) (ft-k) Range in Operating Stroke: _____ to _____ (meters) (ft) Ram Weight: _____ (kips) (kN) Modifications: _____ _____ _____	
		<b>Striker Plate</b> Weight: _____ (kips) (kN) Diameter: _____ (in) (mm) Thickness: _____ (in) (mm)  Material #1 _____ Material #2 _____ (for Composite Cushion) Name: _____ Name: _____ Area: _____ (in <sup>2</sup> ) (cm <sup>2</sup> ) Area: _____ (in <sup>2</sup> ) (mm <sup>2</sup> ) Thickness/Plate: _____ (in) (mm) Thickness/Plate: _____ (in) (mm) No. of Plates: _____ No. of Plates: _____ Total Thickness of Hammer Cushion: _____ (in) (mm)	
		<b>Helmet (Drive Head)</b> Weight: _____ including inserts (kips) (kN)	
		<b>Pile Cushion</b> Material: _____ Area: _____ (in <sup>2</sup> ) (cm <sup>2</sup> ) Thickness/Sheet: _____ (in) (mm) No. of Sheets: _____ Total Thickness of Pile Cushion: _____ (in) (mm)  Pile Type: _____ Wall Thickness: _____ (in) (mm) Taper: _____ Cross Sectional Area: _____ (in <sup>2</sup> ) (mm <sup>2</sup> ) Weight/ft (m): _____	
		<b>Pile</b> Ordered Length: _____ (ft) (m) Design Load: _____ (kips) (kN) Ultimate Pile Capacity: _____ (kips) (kN)  Description of Splice: _____ _____ Driving Shoe/Closure Plate Description: _____ _____ Submitted By: _____ Date: _____ Telephone No.: _____ Fax No.: _____	

**Figure 9-45. Pile and driving equipment data form (after FHWA, 2006a).**

During production operations, the engineer will check if the necessary blow count is attained at the estimated length shown on the pile driving information form. The resistance is generally acceptable if the blow count is within 10 percent of that expected, or if the expected blow count is achieved within 5 ft (1.5 m) of the estimated length. The construction engineer should be aware that blow counts greater than expected will cause an increase in pile stress. If necessary an upper blow count limit may need to be established to prevent damage.

If either radically different blow counts (greater or less) than those predicted from wave equation analysis or damage are observed during the driving process, the foundation designer should be contacted immediately. The phone number of the foundation designer should be on the information form.

It should be realized that pile driving is not by any means an exact science and actual blow counts and pile lengths may be expected to vary somewhat even in the same footing. The objective of construction monitoring of pile driving is to ensure that the pile is capable of supporting the design load safely. This means that the pile is not damaged and adequate soil resistance is mobilized for support. Both these items can be checked from the wave equation analysis output.

The use of wave equation analysis for construction monitoring provides the engineer with a method to predict the behavior of the driven piles during installation. While this prediction is superior to previous methods of estimating driveability, the optimal method of determining pile driveability is to obtain dynamic measurements during pile installation. Dynamic test methods commonly employ accelerometers and strain gages attached to the pile during driving to measure real time strains and accelerations produced during the driving process. Field computers use these measurements to develop driving variables, which the inspector can use to:

- Monitor hammer and driving system performance,
- Evaluate driving stresses and pile integrity, and,
- Verify pile capacity

Additional details of the dynamic test procedure are discussed in the following section.

#### **9.9.10 Dynamic Pile Monitoring**

Dynamic test methods use measurements of strain and acceleration taken near the pile head as a pile is driven or restruck with a pile driving hammer. These dynamic measurements can be used to evaluate the performance of the pile driving system, calculate pile installation stresses, assess pile integrity, and estimate static pile capacity. Dynamic test results can be further evaluated by

using signal matching techniques to determine the relative distribution of soil resistance along the pile, as well as representative dynamic soil properties for use in wave equation analyses. This section provides a brief discussion of the equipment and methods of analysis associated with dynamic measurements.

A typical dynamic monitoring system consists of a minimum of two strain transducers and two accelerometers bolted to diametrically opposite sides of the pile to monitor strain and acceleration and account for nonuniform hammer impacts and pile bending. Because of nonuniform impacts and bending, the use of two diametrically opposite mounted strain transducers is essential for a valid test. The reusable strain transducers and accelerometers are generally attached two to three diameters below the pile head. Almost any driven pile type (concrete, steel pipe, H, Monotube, timber, etc.) can be tested with the pile preparation for each pile type varying slightly.

As the pile is struck by a pile hammer, the strains and accelerations detected by the corresponding gages on the pile are converted into forces and velocities. Typical force and velocity traces generated during dynamic measurements are shown in Figure 9-46. These traces are processed to obtain an estimate of the static pile capacity at the time of testing and for pile design. The additional information obtained and displayed includes compressive and tensile stresses in the pile, transferred energy to the pile, and the force and velocity at the top of the pile throughout the duration of the hammer impact. An experienced operator can use this data to evaluate the performance of the pile driving system and the condition of the pile. The results of the dynamic monitoring are enhanced by the post-testing evaluation in which signal matching is used with computer analysis to verify the correctness of assumed dynamic inputs including damping, quake and load transfer distribution.

ASTM D 4945 contains a detailed description of the equipment requirements and test procedure for dynamic pile load testing.

#### **9.9.10.1 Applications**

Dynamic pile monitoring costs much less and requires less time than static pile load testing. Important information can be obtained regarding the behavior of both the pile-soil system and the pile driving system that is not available from a static pile load test. Determination of driving stresses and pile integrity with dynamic test methods has facilitated the use of fewer, higher capacity piles in foundations through better pile installation control. Some of the applications of dynamic pile testing are discussed below (FHWA, 2006a).

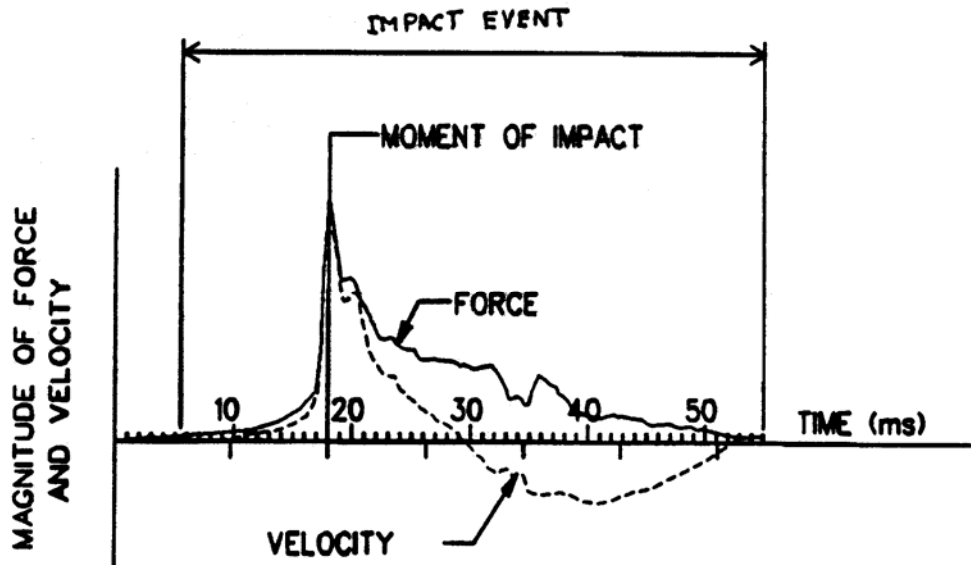

Figure 9-46. Typical force and velocity traces generated during dynamic measurements.

- **Static Pile Capacity**

- a. Evaluation of static pile capacity at the time of testing. Soil setup or relaxation potential can be also assessed by restriking several piles and comparing restrike capacities with end-of-initial driving capacities.
- b. Assessments of static pile capacity versus pile penetration depth can be obtained by testing from the start to the end of driving. This can be helpful in profiling the depth to the bearing stratum and thus the required pile lengths.
- c. Signal matching computer analysis can provide refined estimates of static capacity, assessment of soil resistance distribution, and soil quake and damping parameters for input into a wave equation analysis.

- **Hammer and Driving System Performance**

- a. Calculation of energy transferred to the pile for comparison with the manufacturer's rated energy and wave equation predictions which indicate hammer and drive system performance. Energy transfer can also be used to determine effects of changes in hammer cushion or pile cushion materials on pile driving resistance.

- b. Determination of drive system performance under different operating pressures, strokes, or changes in hammer maintenance by comparative testing of hammers, or of a single hammer over an extended period of use.
- c. Identification of hammer performance problems, such as preignition problems with diesel hammers or preadmission problems in air/steam hammers.
- d. Determination of whether soil behavior or hammer performance is responsible for changes in observed driving resistances.

- **Driving Stresses and Pile Integrity**

- a. Calculation of compression and tension driving stresses. In cases with driving stress problems, this information can be helpful when evaluating adjustments to pile installation procedures are being evaluated. Calculated stresses can also be compared to specified driving stress limits.
- b. Determination of the extent and location of pile structural damage. With dynamic pile monitoring costly extraction may not be necessary to confirm or quantify damage suspected from driving records.
- c. Stress distribution throughout pile by using signal matching computer analysis.

### **9.9.10.2 Interpretation of Results and Correlation with Static Pile Load Tests**

The results of dynamic pile monitoring should be interpreted by an experienced geotechnical specialist who has had the opportunity to observe and evaluate the results from many dynamically test piles and can detect the signs, not always readily apparent, of unusual soil-pile response, pile damage, erratic hammer operation or testing equipment malfunction. It is important that the geotechnical specialist performing the evaluation should have attained an appropriate level of expertise through qualifying examinations by providers of dynamic testing services.

Interpretation of the results of dynamic pile measurements also requires an awareness of the differences in behavior of dynamically and statically loaded piles. Improper correlations of dynamic and static pile loads test may be caused by the following:

- **Incorrectly assumed soil damping, quake and load transfer parameters.** This source of discrepancy can be minimized by performing a post-test computerized analysis to match



measured and computed relationships between force and velocity to determine the most appropriate parameters.

- **Time-related changes in pile capacity.** Depending on soil type and pile characteristics, the capacity of a pile may increase or, less commonly, decrease with time. The principal causes are time-related changes of pore water pressure in cohesive soils and stress relaxation in cohesionless soils. The effects can be assessed by “restriking” the pile at various time intervals after driving and comparing the observed “restrike” capacity to the driving capacity obtained during the initial drive. The pile capacity should be determined during the first few “good” hammer blows during re-strike. When comparing the results of dynamic testing against those of a static pile load test, at least one dynamic test should be performed after completion of static testing.
- **Inadequate pile tip displacement.** Pile tip displacement during dynamic testing may be inadequate to mobilize full end bearing. Frictional resistance between a pile and the surrounding soil is mobilized at a fraction of the pile movement necessary to mobilize full end bearing resistance. A penetration resistance of 10 blows/inch (10 blows/25.4 mm) or higher, may produce insufficient strain in the soil to mobilize full end resistance. This results in an underestimate of the end bearing capacity. For many types of piles, the estimate can be improved by performing a force-velocity match both for the initial drive and for the restrike data. The tip capacity derived from the initial drive is combined with skin resistance from the restrike to obtain the total pile capacity. However, this method may not be applicable for open-ended pipe, H-piles, and precast cylinder piles. In the case of these types of piles, only the structural area of the pile can mobilize the toe bearing during installation. This value of toe bearing may be significantly less than the value that may be experienced in the static load test, since the soil in the static load test will adhere to the pile with time and create a plug.

## **9.10 CAST-IN-PLACE (CIP) PILES**

There are a variety of cast-in-place (CIP) piles as shown in Figure 9-2. In contrast to the driven piles wherein piles manufactured in a factory are driven in the ground, in the case of CIP piles, the load resisting element is constructed in a pre-drilled hole. The load resisting element is often a combination of steel and CIP concrete. As shown previously in Figure 9-2, there are a variety of CIP piles, e.g., drilled shafts, micropiles, auger cast piles, etc.

The design and construction process for CIP piles is shown in Figure 9-47. This process is similar to that for driven piles shown in Figure 9-3 for Blocks 1 to 18. It is in the construction phase where there are major differences between the driven piles and CIP piles. Blocks 19 to 24 are briefly discussed below:

### **Block 19: Review Contractor's Installation Procedures**

The potential that the CIP piles will perform as designed is heavily dependent on the techniques employed by the contractor during construction. For example, soil excavation technique will not be suitable for excavation in IGMs or rocks. The contractor should be required to submit a detailed CIP pile construction procedure that will be reviewed by the geotechnical engineer.

### **Block 20: Set Preliminary Installation Criteria**

Based on the evaluation of the contractor's proposed installation procedures with respect to project installation criteria and any other requirements in the design and specifications, the preliminary approval of the contractor's equipment and procedures can be given. If the contractor's installation procedures are not acceptable, then the process returns to Block 19.

### **Block 21: Install Test Piles and Evaluate Constructability**

Usually, the first CIP pile on a project is considered to be a "test" pile wherein the contractor's proposed equipment and installation procedures are evaluated in the field. Often, where prior experience is not available, the first pile is required to be installed as a sacrificial pile at a location away from the footprint of the production piles. The constructability evaluation of the test pile is critical. Non-destructive (integrity) tests are recommended at this stage to evaluate the quality of the constructed product.

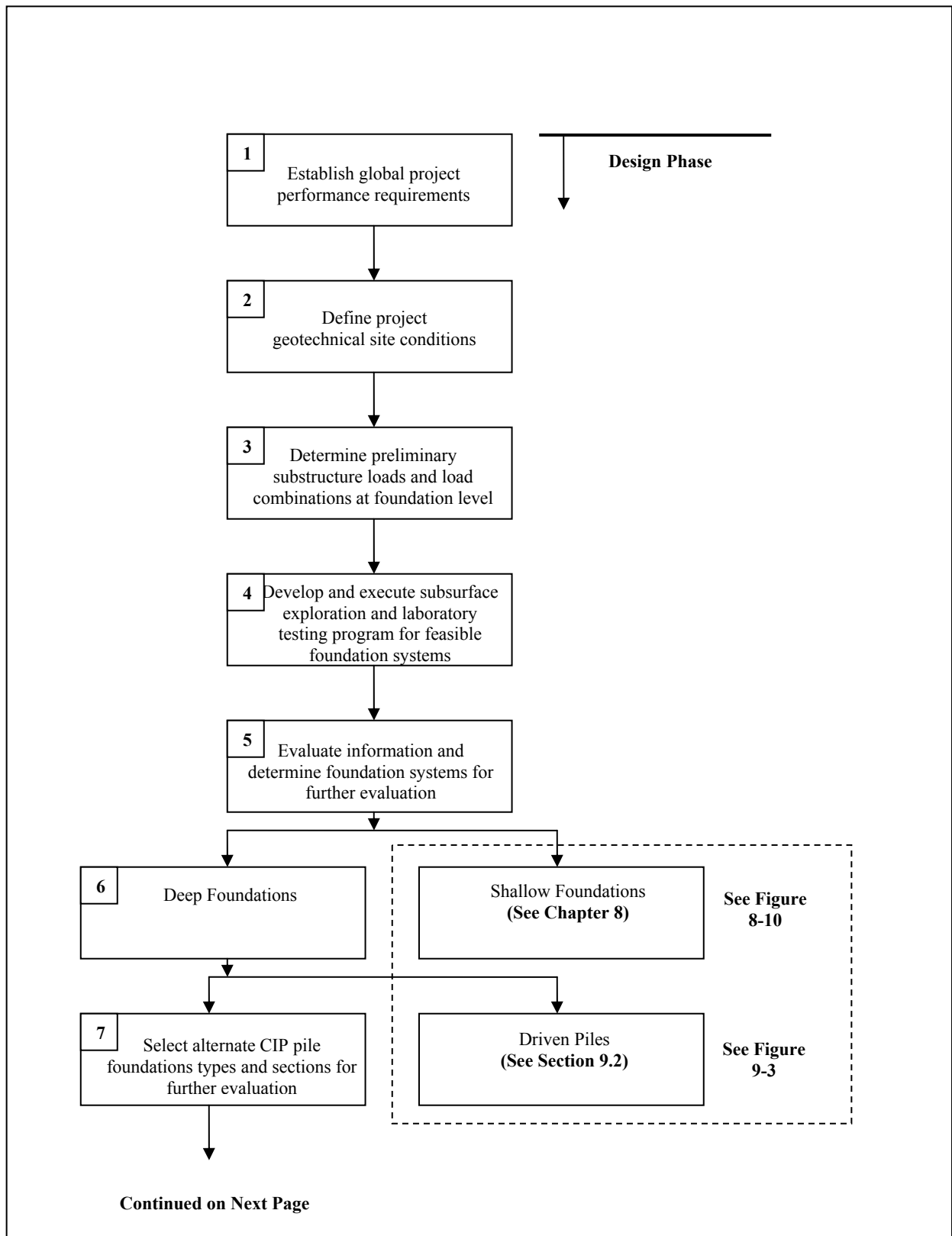

**Figure 9-47. Cast-in-Place (CIP) pile design and construction process (modified after FHWA 2006a).**

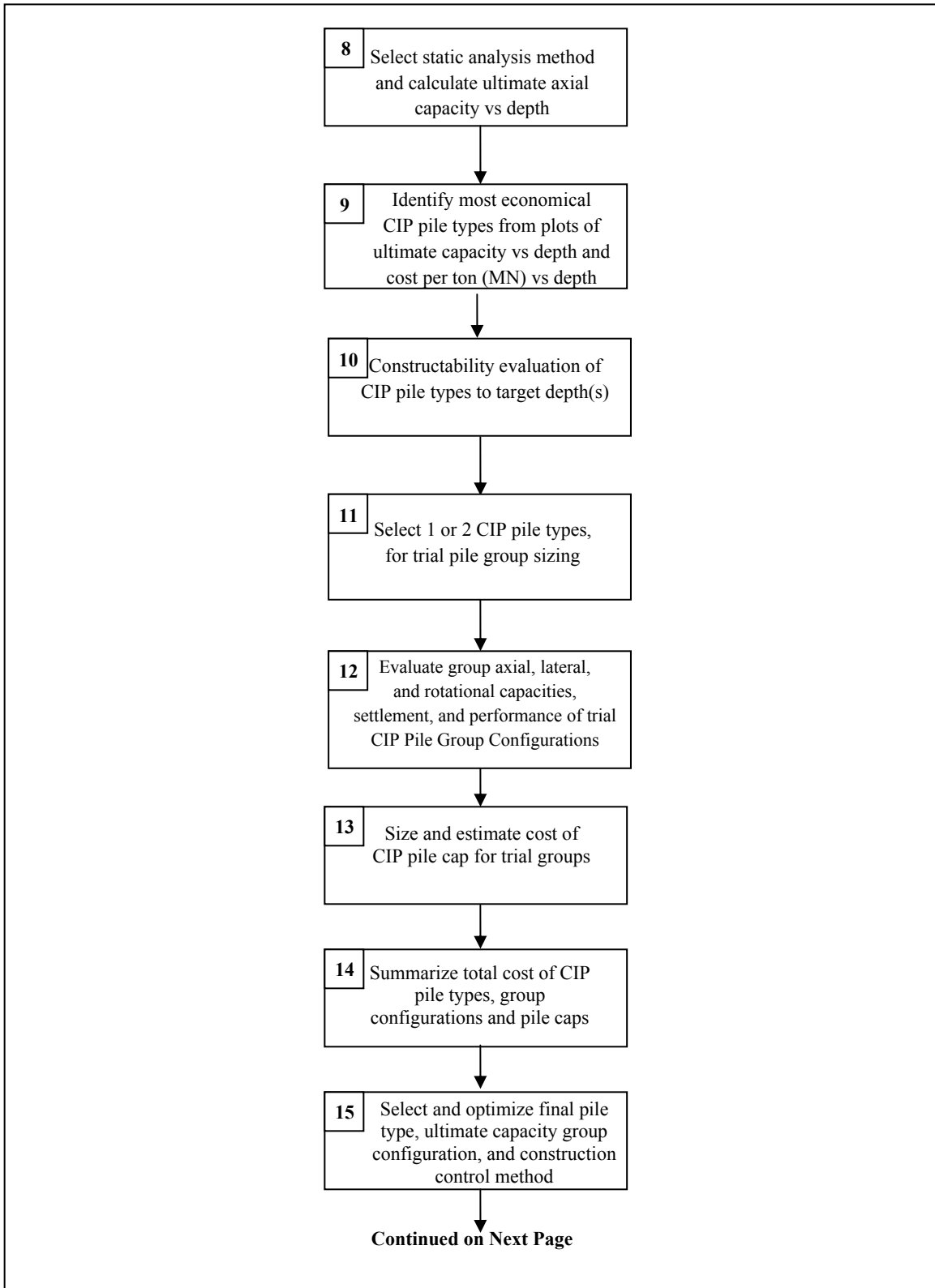

**Figure 9-47 (Continued). Cast-in-Place (CIP) pile design and construction process (modified after FHWA 2006a).**

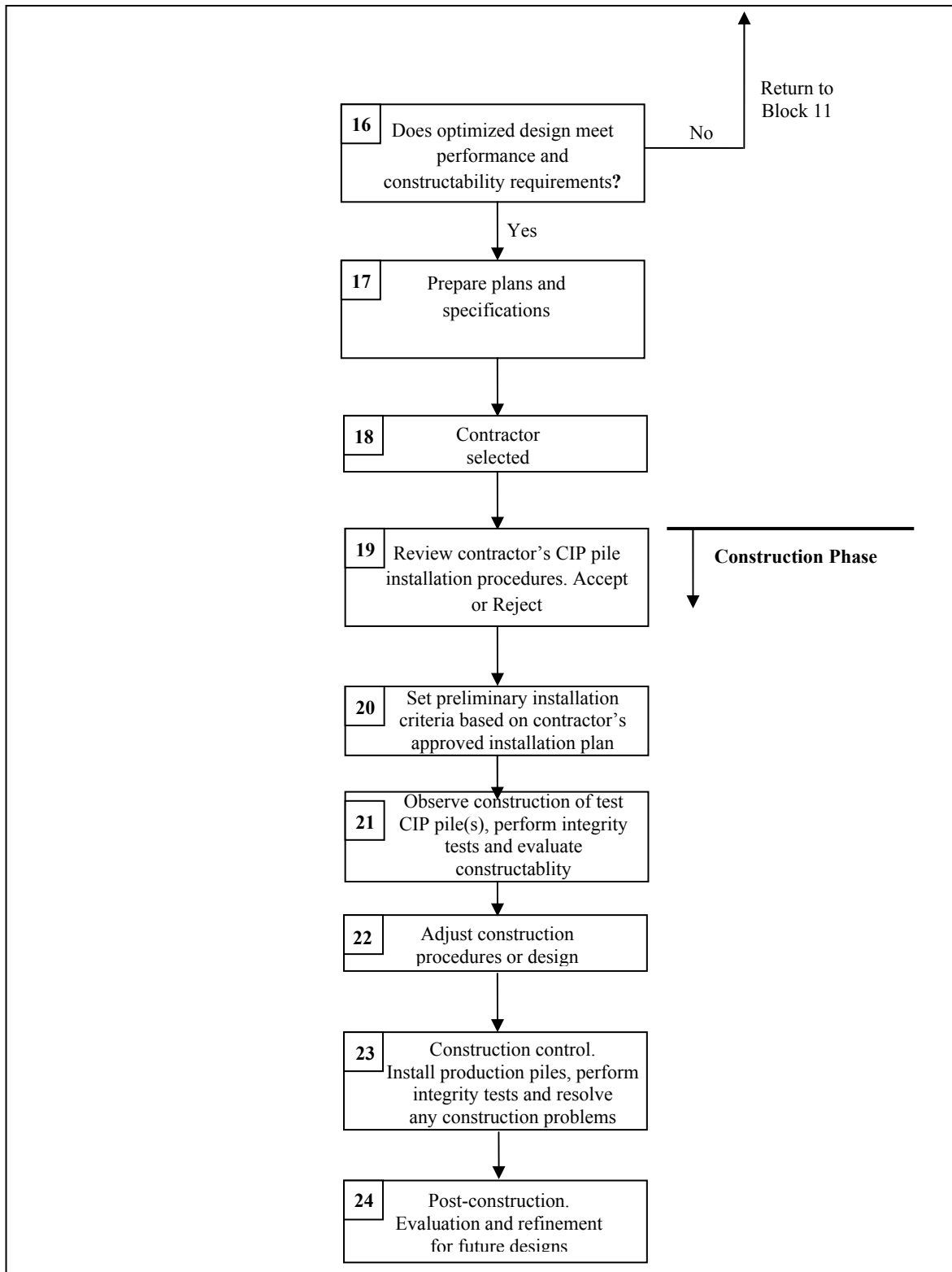

**Figure 9-47 (Continued). Cast-in-Place (CIP) pile design and construction process (modified after FHWA 2006a).**

## **Block 22: Adjust Construction Procedures**

In this step, an adjustment in the contractor's construction procedures may be required prior to construction of the production piles. If significant adjustments are necessary, then another test pile may be warranted.

## **Block 23: Construction Control**

After the test CIP pile has been successfully constructed, the same construction procedures are applied for the production piles unless different subsurface conditions are encountered that may warrant alternative construction techniques. In this case another test pile may be required. Quality control and assurance procedures including integrity tests are implemented as discussed in Section 9.14. Problems may arise and must be handled in a timely fashion as they occur.

## **Block 24: Post-Construction Evaluation and Refinement of Design**

After completion of the foundation construction, the project should be reviewed and evaluated for its effectiveness in satisfying the project requirements and also its cost effectiveness. The evaluation should be performed from the viewpoint of refining the construction and design procedures as appropriate for future projects.

## **9.11 DRILLED SHAFTS**

A drilled shaft is a form of cast-in-place (CIP) pile. A drilled shaft is a machine- and/or hand-excavated shaft in soil or rock that is filled with concrete and reinforcing steel, with the primary purpose of providing structural support. A drilled shaft is usually circular in cross section and may be belled at the base to provide greater bearing area. A typical drilled shaft is shown in Figure 9-48. Other terminology commonly used to describe a drilled shaft includes: drilled pier, drilled caisson, bored pile and cast-in-drilled hole (CIDH). Rectangular drilled shafts are called barrettes.

Vertical load is resisted by the drilled shaft in base bearing and side friction. Horizontal load is resisted by the shaft in horizontal bearing against the surrounding soil or rock.

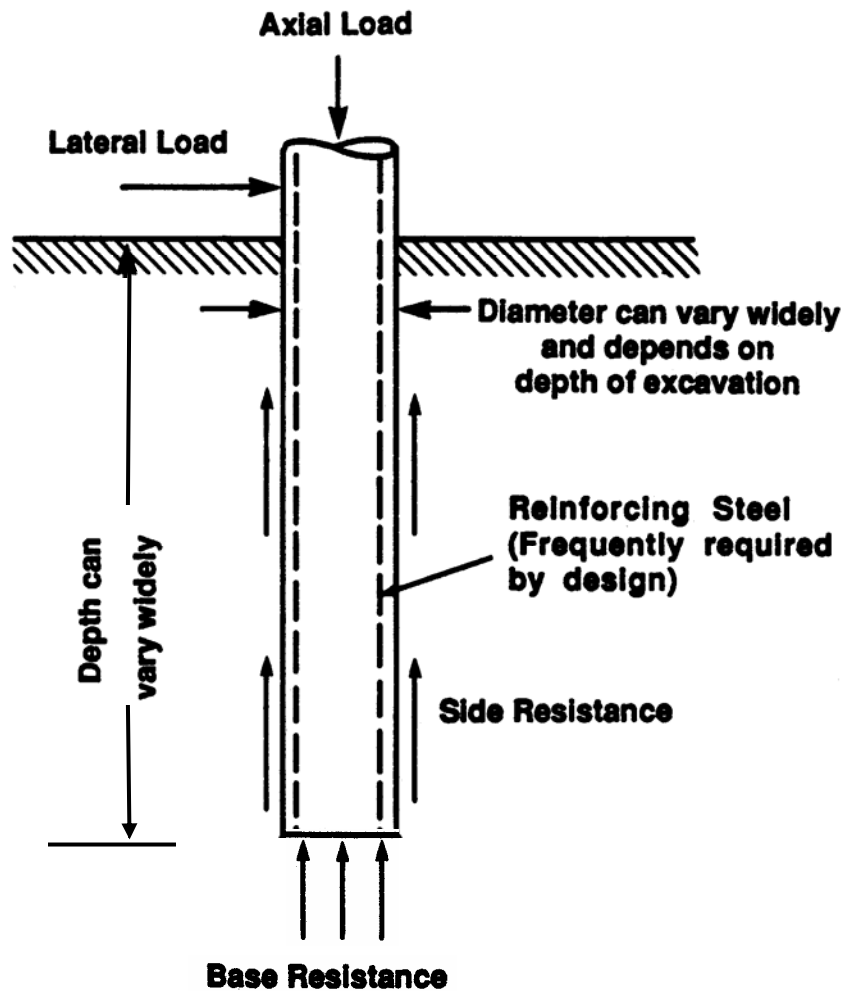

Figure 9-48. A typical drilled shaft and terminology (after FHWA, 1999).

### 9.11.1 Characteristics of Drilled Shafts

The following special features distinguish drilled shafts from driven pile foundations:

1. The drilled shaft is constructed in a drilled hole, unlike the driven pile.
2. Wet concrete is cast and cures directly against the soil in the borehole. Temporary steel casing may be necessary for stabilization of the open hole and may or may not be extracted.
3. The construction method for drilled shafts is adapted to suit the subsurface conditions.

### 9.11.2 Advantages of Drilled Shafts

Following are the advantages of drilled shafts.

- a. Construction equipment is normally mobile and construction can proceed rapidly.
- b. The excavated material and the drilled hole can often be examined to ascertain whether or not the soil conditions at the site agree with the estimated soil profile. For end-bearing situations, the soil beneath the tip of the drilled shaft can be probed for cavities or for weak soil.
- c. Changes in geometry of the drilled shaft may be made during the course of the project if the subsurface conditions so dictate.
- d. The heave and settlement at the ground surface due to installation will normally be very small.
- e. The personnel, equipment, and materials for construction is usually readily available.
- f. The noise level from the equipment is less than for some other methods of construction.
- g. The drilled shaft is applicable to a wide variety of subsurface conditions. For example, it is possible to drill through a layer of cobbles and into hard rock for many feet. It is also possible to drill through frozen ground.
- h. A single drilled shaft can sustain very large loads so that a pile cap may not be needed.
- i. Databases that contain documented load-transfer information are available. These databases allow confident designs of drilled shafts to be made in which load-transfer both in end bearing and in side resistance can be considered.
- j. The shaft occupies less area than the footing and thus can be built closer to railroads, existing structures and constricted areas.
- k. Drilled shafts may be more economical than spread footing construction, especially when the foundation support layer is deeper than 10' below the ground or at water crossings.



### **9.11.2.1 Special Considerations for Drilled Shafts**

- a. Construction procedures are critical to the quality of the drilled shaft. Knowledgeable inspection is required.
- b. Drilled shafts are not normally used in deep deposits of soft clay or in situations where artesian pressures exist.
- c. Static load tests to verify the ultimate capacity of large diameter shafts are very costly.

### **9.11.3 Subsurface Conditions and Their Effect on Drilled Shafts**

Subsurface investigation for drilled shaft designs must include an assessment of the potential methods of shaft construction as well as a determination of soil properties. The standard method for obtaining soil characteristics is similar to pile foundations and involves laboratory testing of undisturbed samples and the use of in situ techniques including the standard penetration test. Constructability is difficult to assess from routine geotechnical investigations. Critical items such as hole caving, dewatering, rock drilling and obstructions can best be examined by drilling a full diameter test shaft hole during the exploration or design phase of the project. These test holes are usually done by local drilled shaft contractors under a short form contract. Prospective bidders should be invited to observe the construction of the test hole. A detailed log should be made of the test hole including items such as type of drilling rig, rate of drilling, type of drill tools and augers used, etc. Such information should be made available for bidders.

#### **Subsurface Conditions Affecting Construction**

- a. The stability of the subsurface soils against caving or collapse when the excavation is made will determine whether or not a casing is necessary. The dry method of construction can be used only where the soils will not cave or collapse. The casing method must be used if there is danger of caving or collapse.
- b. The existence of groundwater at the site must be determined and what rate of flow can be expected into a shaft excavation. This knowledge will permit selection of appropriate slurry type and dosage to support the sides and the bottom of the shaft during drilling and subsequent placement of reinforcing cage and concrete. The groundwater can be regional groundwater or perched water.
- c. Any artesian water conditions must be clearly identified in the contract documents. Artesian water flowing could spoil the concrete placement, or cause collapse or

heaving at the excavation. Flowing water can create similar problems during concrete placement as it can leach the cement grout out of the concrete mix. Conventional slurry-assisted drilling alone may not be adequate in cases where artesian pressure is encountered and casing may be required.

- d. The presence of cobbles or boulders can cause difficulties in drilling. It is sometimes not easy to extract large pieces of rock, especially with smaller diameter shafts.
- e. The presence of existing foundations or structures.
- f. The presence of landfill that could contain material that cannot be easily excavated, such as an old car body.
- g. The presence of rock may require more sophisticated drilling methods.
- h. The presence of a weak stratum just below the base of the drilled shaft. For this situation drilling may have to be extended below the weak stratum.

## **9.12 ESTIMATING AXIAL CAPACITY OF DRILLED SHAFTS**

The procedures for estimation of drilled shaft capacity have improved significantly over the past decade. The major reason for this improvement is a database that has been developed on load transfer in skin friction and in end bearing based on load tests in a broad range of geomaterials. It is now well established that drilled shafts can carry a substantial portion of applied loads in skin friction. As with pile foundations, the ultimate skin friction is mobilized at a relatively small downward movement of the shaft relative to the soil. End bearing resistance is developed in relation to the amount of deflection at the tip.

Separate analyses are required to determine skin friction and end bearing contributions in different soil types and rock. Details of these analyses can be found in FHWA (1999). The basic formulation for drilled shaft capacity in soils and rocks, excerpted from FHWA (1999), is presented herein. The discussions in this manual regarding drilled shaft axial capacity are limited to drilled shafts of uniform cross-section, with vertical alignment, concentric axial loading, and a relatively horizontal ground surface. The reader is referred to FHWA (1999) for procedures to incorporate the effects of enlarged base, group action, and sloping ground.

The ultimate axial capacity ( $Q_{ult}$ ) of the drilled shaft is determined as follows for compression and uplift loading, respectively:

$$Q_u = Q_s + Q_t - W \quad 9-34a$$

$$Q_u \leq 0.7Q_s + W \quad 9-34b$$

where:  $Q_u$  = total ultimate axial capacity of the foundation  
 $Q_s$  = ultimate skin (side) capacity  
 $Q_t$  = ultimate tip (base or end) capacity  
 $W$  = weight of the shaft.

Note that in contra-distinction to the ultimate capacity equation for driven piles (see Equation 9-1), the weight term is included for the drilled shaft since the weight of a shaft is usually much larger than that of a pile. The shaft weight can therefore act as a load in the downward direction or act as a resistance in uplift.

Similar to the driven piles, the **allowable geotechnical soil resistance**,  $Q_a$ , is determined as follows:

$$Q_a = \frac{Q_u}{FS} \quad 9-35$$

where FS = factor of safety which typically varies between 2 to 3. If load tests are not performed then the shaft should be designed for a minimum factor of safety of 2.5 (AASHTO, 2002). This minimum recommended factor of safety is based on an assumed normal level of field quality control during shaft construction as per the requirements of FHWA (2002d). If a normal level of field quality control as required by FHWA (2002d) cannot be assured, larger minimum factors of safety such as 3.0 are recommended. If a site-specific load test is performed, consideration may be given to reducing the factor of safety from 2.5 to 2.0.

Shafts in cohesive soils may be designed by total and effective stress methods of analysis, for undrained and drained conditions, respectively. Shafts in cohesionless soils should be designed by effective stress methods of analysis for drained loading conditions. Formulations for both cohesive and cohesionless soils using allowable stress design (ASD) are presented herein based FHWA (1999) and AASHTO (2002). For LRFD based formulations the reader is referred to AASHTO (2004 with 2006 Interims).

### 9.12.1 Side Resistance in Cohesive Soil

For cylindrical shafts in cohesive soils loaded under undrained loading conditions, the **ultimate side resistance** may be estimated by using the following expression:

$$Q_s = \pi D \sum_{i=1}^N \alpha_i s_{ui} \Delta z_i \quad 9-36$$

Where,  $D$  is the diameter of the shaft and  $\alpha_i$  and  $s_{ui}$  are the adhesion factor and undrained shear strength, respectively, in a layer  $\Delta z_i$ . The adhesion factor,  $\alpha$ , is given as follows.

$$\alpha = 0.55 \quad \text{for } s_u/p_a \leq 1.5 \quad 9-37a$$

$$\alpha = 0.55 - 0.1(s_u/p_a - 1.5) \quad \text{for } 1.5 < s_u/p_a \leq 2.5 \quad 9-37b$$

where  $p_a$  = atmospheric pressure (=1.06 tsf = 2.12 ksf = 14.7 psi = 101kPa). The units of  $s_{ui}$  and  $p_a$  should be dimensionally consistent.

The **ultimate unit load transfer in side resistance** at any depth  $f_{si}$  is given as follows:

$$f_{si} = \alpha_i s_{ui} \quad 9-38$$

As illustrated in Figure 9-49, the top and bottom 5-ft of the shaft should not be included in the development of the ultimate skin resistance. Environmental, long-term loading or construction factors may dictate that a depth greater than the top 5-ft should be ignored in estimating  $Q_s$ .

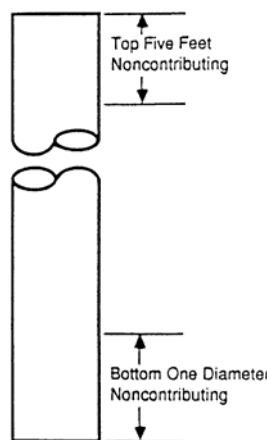

**Figure 9-49. Portions of drilled shafts not considered in computing ultimate side resistance (FHWA, 1999).**

Effective stress methods for computing  $Q_s$  described in Section 9.10.2.3 may be used for the following cases:

- For shafts in cohesive soils under drained loading conditions, and
- In the zones where time-dependent changes in soil shear strength may occur, e.g., swelling of expansive clay or downdrag from a consolidating clay.

### 9.12.1.1 Mobilization of Side Resistance in Cohesive Soil

Figure 9-50 presents the load-transfer characteristics for side resistance in cohesive soils. The curves presented indicate the proportion of the ultimate side resistance ( $Q_s$ ) mobilized at various magnitudes of settlement. It can be seen that the full ultimate side resistance is mobilized at displacements of 0.2% to 0.8% of the shaft diameter. Thus, for a 4-ft diameter shaft in cohesive soil, full side resistance will be mobilized at vertical displacements in the range of 1/8" to 3/8" (3 mm to 10 mm).

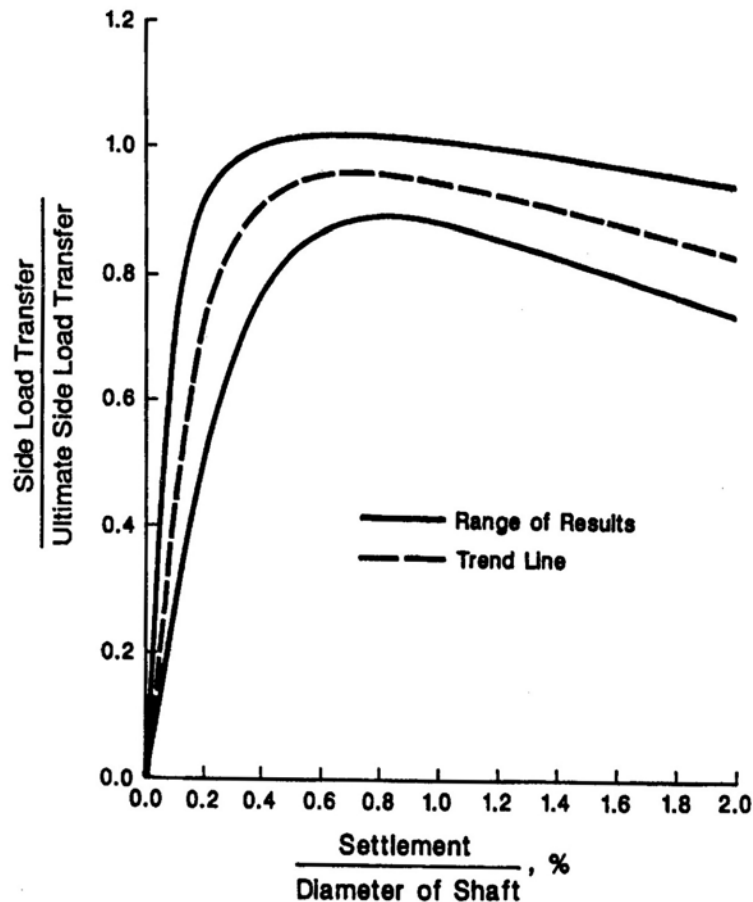

**Figure 9-50. Load-transfer in side resistance versus settlement for drilled shafts in cohesive soils (FHWA, 1999).**

### 9.12.2 Tip Resistance in Cohesive Soil

For axially loaded shafts in cohesive soil subjected to undrained loading conditions, the ultimate tip resistance of drilled shafts may be estimated by using the following relationship:

$$Q_t = q_t A_t = N_c s_{ut} A_t \quad 9-39$$

Where  $q_t$  is the unit tip resistance,  $N_c$  is a bearing capacity factor,  $s_{ut}$  is the undrained shear strength of the soil at the tip of the shaft and  $A_t$  is the tip area of the shaft. Values of the bearing capacity factor,  $N_c$ , may be determined by using the following relationship.

$$N_c = 6.0[1+0.2(z/D)]; \quad N_c \leq 9 \quad 9-40$$

where  $z$  is the depth of the penetration of the shaft and  $D$  is the diameter of the shaft. The units of  $z$  and  $D$  should be consistent.

The limiting value of unit end bearing ( $q_t = N_c s_{ut}$ ) is 80 ksf. The value of 80 ksf is not a theoretical limit but a limit based on the largest measured values. A higher limiting value may be used if it is based on the results of a load test, or previous successful experience in similar soils under similar loading conditions.

The value of  $s_{ut}$  should be determined from the results of in-situ and/or laboratory testing of undisturbed samples obtained within a depth of 2.0 diameters below the tip of the shaft. If the soil within 2.0 diameters of the tip has  $s_{ut} < 0.5$  ksf, the value of  $N_c$  should be multiplied by 0.67.

#### 9.12.2.1 Mobilization of Tip Resistance in Cohesive Soil

Figure 9-51 presents the load-transfer characteristics for tip resistance in cohesive soils. The curves presented indicate the proportion of the ultimate tip resistance ( $Q_t$ ) mobilized at various magnitudes of settlement. It can be seen that the ultimate tip resistance,  $Q_t$ , is fully mobilized at displacements of 2% to 5%. Thus, for a 4-ft diameter shaft in cohesive soil, full tip resistance will be mobilized at vertical displacements in the range of 1" to 2.5" (25 mm to 65 mm). Conversely, if the shaft settles less than these values, then full tip resistance may not be mobilized. For example, if the shaft settles only 1% of the shaft diameter then approximately 60% of the tip resistance will be mobilized as indicated by the trendline shown in Figure 9-51. For smaller tolerable settlements, the mobilized tip resistance will be similarly smaller. If one limits the deformation to between 0.2% and 0.8% to be consistent with full mobilization of side resistance in cohesive soil, then from Figure 9-51, it can be seen that only approximately 10 to 50% of the tip resistance will be available based on the trendline.

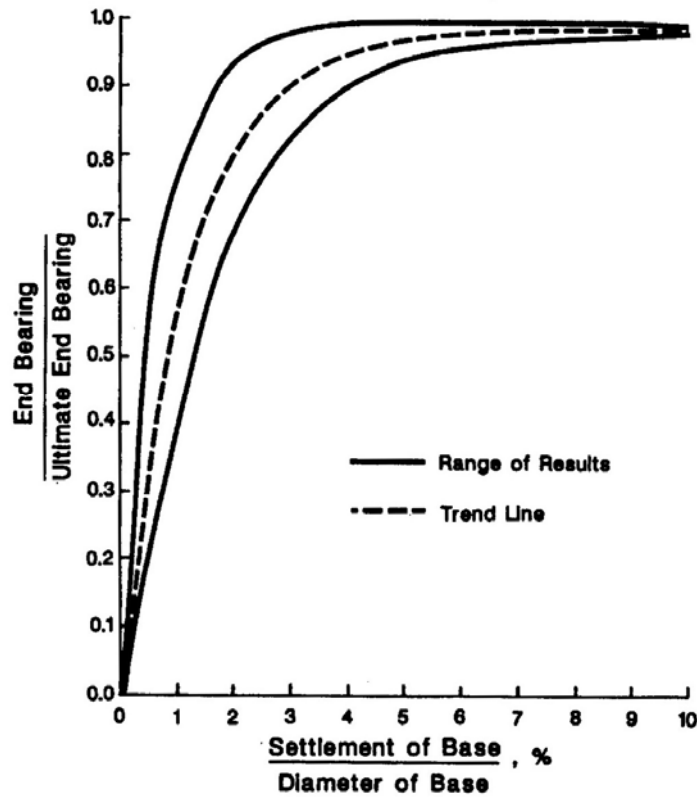

**Figure 9-51. Load-transfer in tip resistance versus settlement for drilled shafts in cohesive soils (FHWA, 1999).**

The above examples of shaft settlements clearly demonstrate the need to perform detailed settlement analyses by using Figure 9-50 and 9-51 to estimate the shaft resistance based on consistent deformations. For shafts in cohesive soil under drained loading conditions,  $Q_t$ , may be estimated by using the procedure described in Section 9.12.3.1 for cohesionless (drained) soils.

### 9.12.3 Side Resistance in Cohesionless Soil

For cylindrical shafts in cohesionless soil or for effective stress analysis of cylindrical shafts in cohesive soils under drained loading conditions, the ultimate side resistance of axially loaded drilled shafts may be estimated by using the following equation:

$$Q_s = \pi D \sum_{i=1}^N \beta_i p_o \Delta z_i \quad 9-41$$

where:  $\beta_i = 1.5 - 0.135\sqrt{z_i}$  with  $1.2 > \beta_i > 0.25$  9-42

In above equations  $D$  is the shaft diameter,  $N$  is the number of layers used in the analysis,  $z_i$  is the depth in feet to the center of the  $i^{\text{th}}$  layer and  $p_o$  is the effective overburden pressure at the center of the  $i^{\text{th}}$  layer. The ultimate unit load transfer in side resistance at any depth  $f_{si}$  is given as follows:

$$f_{si} = \beta_i p_o \quad 9-43$$

The limiting value of  $f_{si}$  for shafts in cohesionless soils is 4 ksf (191 kPa).

### 9.12.3.1 Mobilization of Side Resistance in Cohesionless Soil

Figure 9-52 presents the load-transfer characteristics for side resistance in cohesionless soils. The curves presented indicate the proportion of the ultimate side resistance ( $Q_s$ ) mobilized at various magnitudes of settlement. It can be seen that the full ultimate side resistance,  $Q_s$ , is fully mobilized at displacements of 0.1% to 1.0% of the shaft diameter. Thus, for a 4-ft diameter shaft in cohesionless soil, full side resistance will be mobilized at vertical displacements in the range of 0.05" to 0.5" (1.3 to 13 mm).

### 9.12.4 Tip Resistance in Cohesionless Soil

For axially load drilled shafts in cohesionless soils or for effective stress analysis of axially loaded drilled shafts in cohesive soils, the ultimate tip resistance may be estimated by using the following equation:

$$Q_t = q_t A_t \quad 9-44$$

The value of  $q_t$  may be determined from the results of standard penetration testing using  $N_{60}$  blow count readings within a depth of  $2B$  below the tip of the shaft as follows:

$$\text{For } N_{60} \leq 75: \quad q_t = 1.2N_{60} \quad \text{in ksf} \quad 9-45a$$

$$\text{For } N_{60} > 75: \quad q_t = 90 \text{ ksf} \quad 9-45b$$



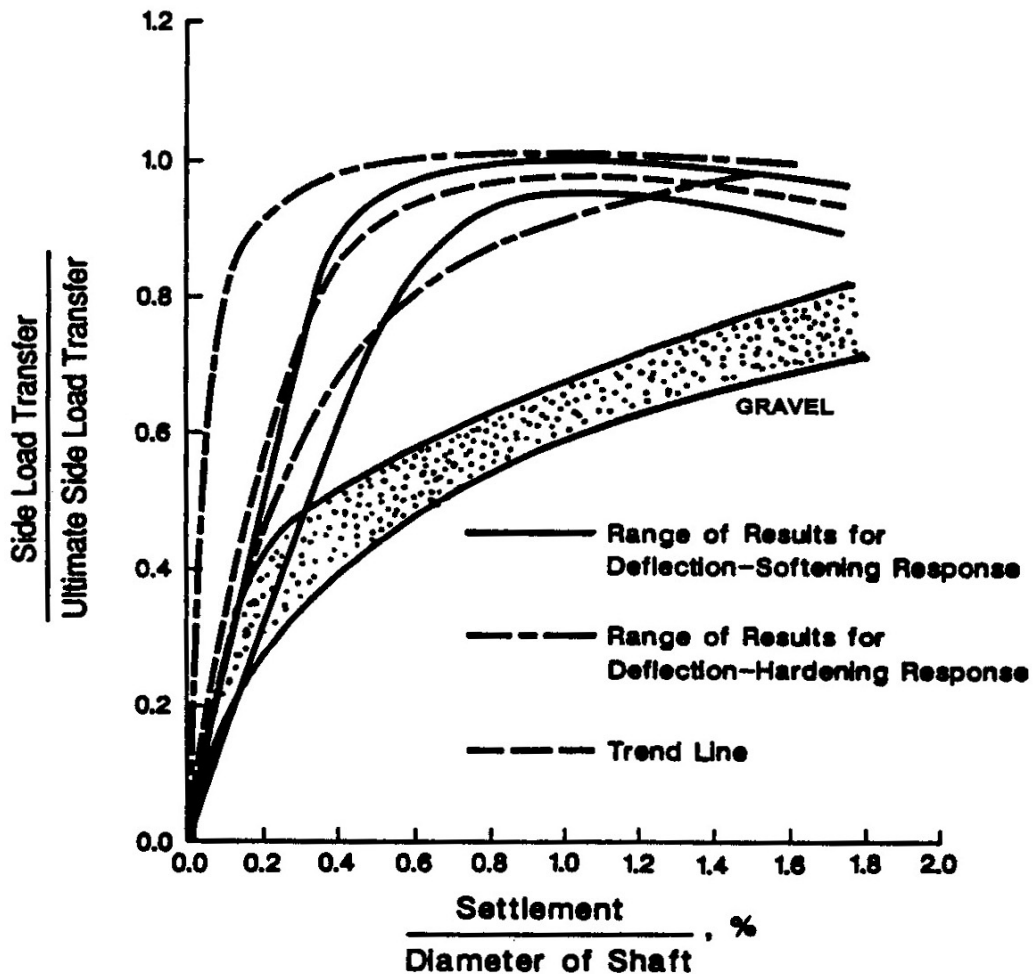

Figure 9-52. Load-transfer in side resistance versus settlement for drilled shafts in cohesionless soils (FHWA, 1999).

#### 9.12.4.1 Mobilization of Tip Resistance in Cohesionless Soil

Figure 9-53 presents the load-transfer characteristics for tip resistance in cohesionless soils. The curves presented indicate the proportion of the ultimate tip resistance ( $Q_t$ ) mobilized at various magnitudes of settlement. It can be seen that the ultimate tip resistance,  $Q_t$ , is fully mobilized at displacements of approximately 5%. Thus, for a 4-ft diameter shaft in cohesive soil, full tip resistance will be mobilized at vertical displacements of approximately 2.4-inches. Conversely, if the shaft settles less than this value, then full tip resistance may not be mobilized. For example if the shaft settles only 1% of the shaft diameter then approximately 30% of the tip resistance will be mobilized as indicated by the trendline shown in Figure 9-53. For smaller settlements, the mobilized tip resistance will be similarly smaller. If one limits the deformation to between

0.1% and 1% to be consistent with full mobilization of side resistance in cohesionless soils, then from Figure 9-53, it can be seen that only approximately 5 to 30% of the tip resistance will be available based on the trendline.

Compared to similar examples for cohesive soils, it can be seen that deformation compatibility is more critical in cohesionless soils due to the relatively large deformation of 5% of shaft diameter that is required to mobilize full tip resistance. This reinforces the need to perform detailed settlement analyses by using Figure 9-52 and 9-53 to estimate the shaft resistance based on consistent deformations.

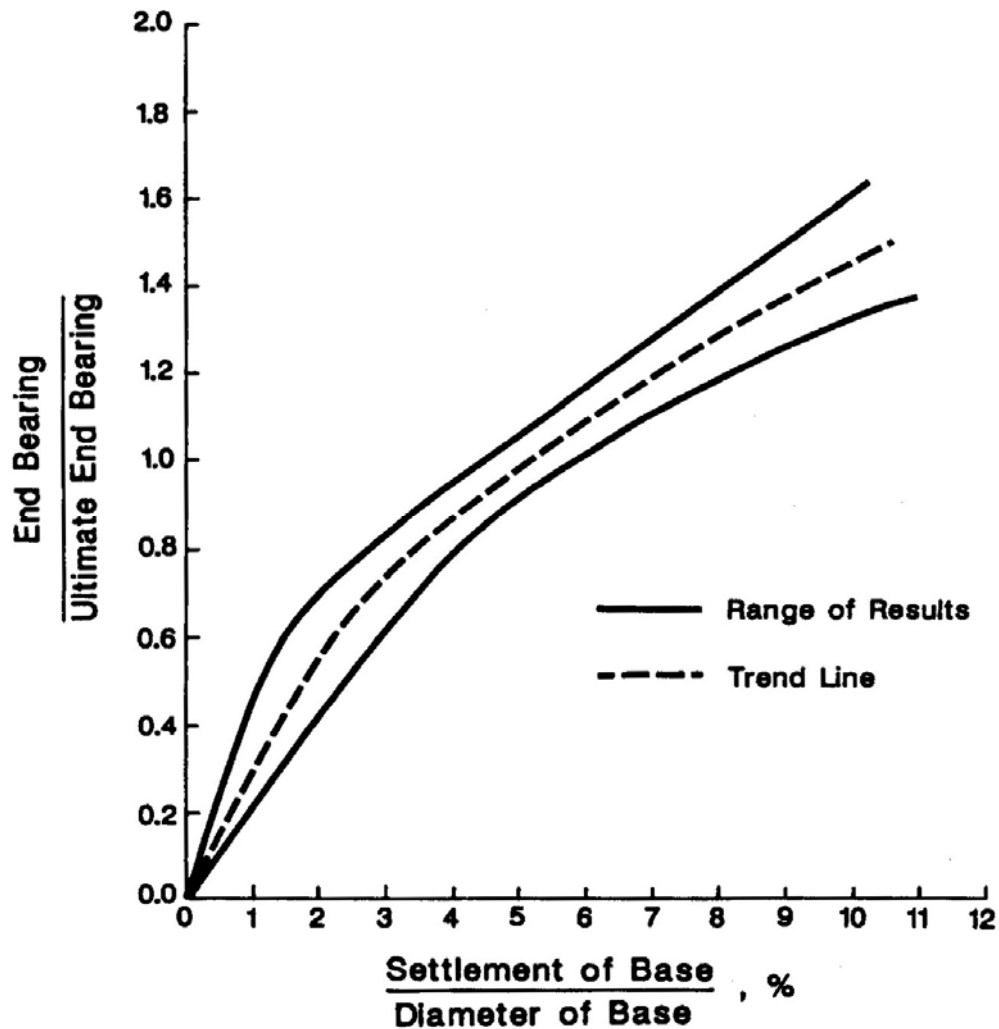

Figure 9-53. Load-transfer in tip resistance versus settlement for drilled shafts in cohesionless soils (FHWA, 1999).

### **9.12.5 Determination of Axial Shaft Capacity in Layered Soils or Soils with Varying Strength with Depth**

The design of shafts in layered soil deposits or soil deposits having variable strength with depth requires evaluation of soil parameters characteristic of the respective layers or depth. The side resistance,  $Q_s$ , in such soil deposits may be estimated by dividing the shaft into layers according to soil type and properties, determining  $Q_s$  for each layer, and summing the values for each layer to obtain the total load  $Q_s$ . If the soil below the shaft tip is of variable consistency,  $Q_t$ , may be estimated using the strength properties of the predominant soil strata within a depth of 2 shaft diameters below the shaft tip. While summing the resistances, particular attention must be paid to deformation compatibility.

For shafts extending through soft compressible layers to firm soil or rock, consideration should be given to the effects of negative skin friction due to the potential consolidation settlement of soils surrounding the shaft. Where the shaft tip would bear on a thin firm soil layer underlain by a softer soil unit, the shaft should be extended through the softer soil unit to eliminate the potential for a punching shear failure into the softer deposit.

### **9.12.6 Group Action, Group Settlement, Downdrag and Lateral Loads**

These topics are similar to those for pile foundations. Their detailed discussion is beyond the scope of this manual. The reader is referred to FHWA (1999) for discussion of these topics.

The concepts regarding axial capacity of drilled shafts in cohesionless or drained cohesive soils are illustrated numerically by Example 9-5. The concepts regarding axial capacity of drilled shafts in layered soils are illustrated numerically by Example 9-6.

**Example 9-5:** Size a shaft to resist 170 tons of vertical design load in the soil profile shown below. Assume a factor of safety (FS) of 2.5.

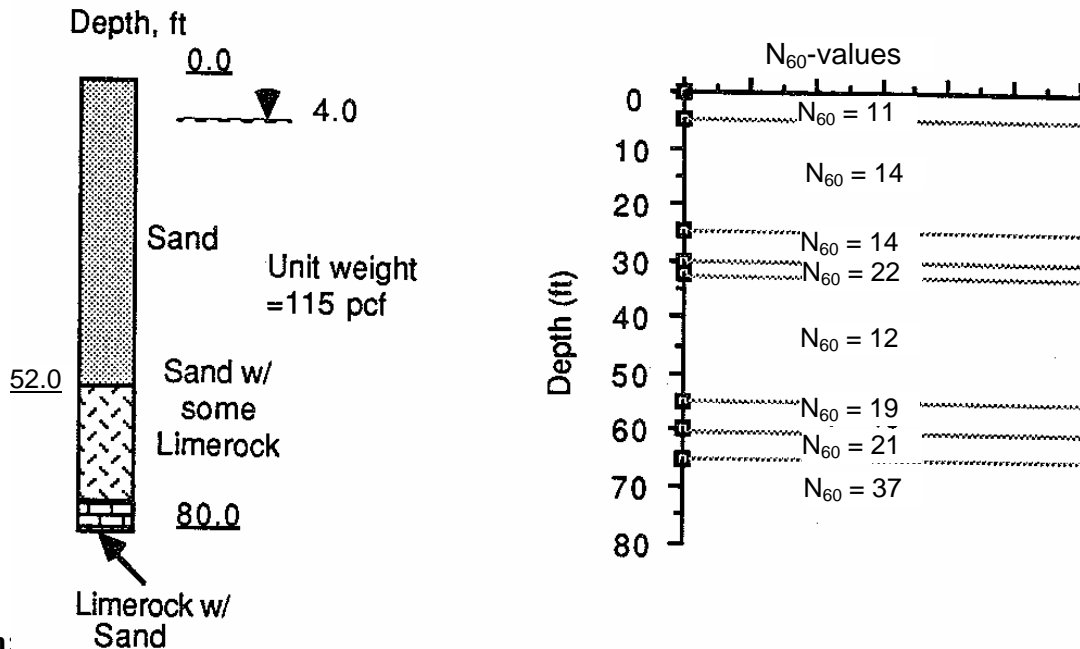

**Solution:**

The ultimate geotechnical axial load = (FS) (Design Load) = (2.5) (170 tons) = 425 tons. Assume a straight-sided drilled shaft with a diameter of 3-ft and a length of 60-ft. Thus,  $\pi(D) = 9.42\text{-ft}$

Use Equation 9-41 to determine ultimate skin resistance,  $Q_s = \pi D \sum_{i=1}^N \gamma_i z_i \beta_i \Delta z_i$

Depth Interval, $\Delta z$ , ft	Surface Area per depth interval, $\Delta z(\pi)(D)$ , ft <sup>2</sup>	Average effective vertical (overburden) stress, $p_o = \gamma z_i$ tsf	$\beta$ $\beta_i = 1.5 - 0.135\sqrt{z_i}$ with $1.2 > \beta_i > 0.25$	$\Delta Q_s$ Tons
0 – 4	37.7	0.115	1.20	5.20
4 – 30	245.0	0.572	0.94	131.70
30 – 60	282.7	1.308	0.59	218.20
<b>Q<sub>s</sub></b>				<b>355.10</b>

Base resistance ( $N_{60}=21$  at 60-ft). Using Equation 9-45a  $q_t = 1.2N_{60} = 25.2 \text{ ksf} = 12.6 \text{ tsf}$   
 $A_t = 7.07 \text{ ft}^2$  Therefore,  $Q_t = (7.07 \text{ ft}^2) (12.6 \text{ tsf}) = 89.1 \text{ tons}$

Thus, ultimate geotechnical axial resistance,  $Q_{ult}$  is given by:

$$Q_u = 355.1 + 89.1 = 444.2 \text{ tons} \approx 440 \text{ tons} > 425 \text{ tons} \quad \text{Okay.}$$

**Example 9-6:** Determine the shaft length to resist 150 tons of vertical design load in the mixed (clay on sand) soil profile shown below. Assume a safety factor of 2.5. Assume a total unit weight of 125 pcf for clay and 115 pcf for sand. Water table is at a depth of 17-ft. Assume depth of zone of seasonal moisture change to be 5-ft. Once the shaft is sized for ultimate load, check the deformation under design load of 150 tons.

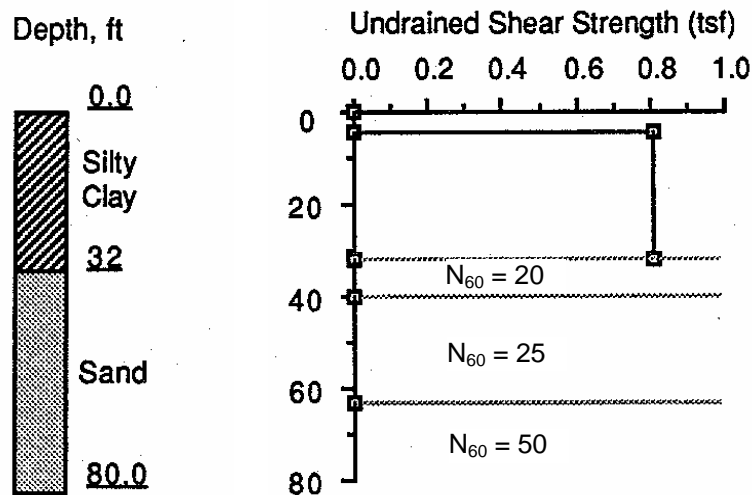

**Solution:**

For a factor of safety of 2.5, the ultimate axial load is computed to be (2.5)(150 tons) = 375 tons.

For a straight-sided shaft with a diameter of 3.0-ft and a depth of penetration of 50-ft,  $\pi(D) = 9.42$ -ft

Use Equation 9-36 and 9-41,

$$Q_s = \pi D \sum_{i=1}^N \alpha_i s_{ui} \Delta z_i$$

$$Q_s = \pi D \sum_{i=1}^N \gamma'_i z_i \beta_i \Delta z_i$$

Soil	Depth Interval, $\Delta z$ , ft	Surface Area per depth interval, $\Delta z(\pi)(D)$ , ft <sup>2</sup>	Shear Strength or Average effective vertical (overburden) stress, tsf	$\alpha$ or $\beta$	$\Delta Q_s$ Tons
Clay	0 – 5	--	--	0.00	0
Clay	5-32	254.5	0.80 (shear strength)	$\alpha = 0.55^*$	112.0
Sand	32-50	169.6	$\{(17 \text{ ft} \times 125 \text{ pcf}) + (32 \text{ ft} - 17 \text{ ft})(125 \text{ pcf} - 62.4 \text{ pcf}) + 9 \text{ ft}(115 \text{ pcf} - 62.4 \text{ pcf})\} / 2,000 = 3537.4 \text{ psf} / 2,000 = 1.769 \text{ tsf}$	$\beta = 0.64^{**}$	192.0
* From Equation 9-37a				$Q_s$	304.0
** From Equation 9-42, $\beta_i = 1.5 - 0.135\sqrt{z_i}$ At mid-depth of sand layer, $z_i = 32 \text{ ft} + (50 \text{ ft} - 32 \text{ ft})/2 = 41 \text{ ft}$ At $z_i = 41 \text{ ft}$ , $\beta_i = 1.5 - 0.135\sqrt{41 \text{ ft}} \approx 0.64$					

Base resistance ( $N_{60}=25$  at 50 ft)

Use Equation 9-45a

$$q_t = 1.2N_{60} = 1.2(25) = 30 \text{ ksf} = 15 \text{ tsf}$$

$$A_t = 7.07 \text{ ft}^2$$

$$Q_t = (7.07 \text{ ft}^2)(15.0 \text{ tsf}) = 106 \text{ tons}$$

Total ultimate axial resistance,  $Q_{ult}$  is given by:

$$Q_u = 304.0 + 106.0 = 416.0 \text{ tons} > 375 \text{ tons} \quad \text{Okay.}$$

#### Check of settlement under design load (150 tons)

Because most of the load in side resistance and all of the end bearing are derived from sand, Figures 9-52 and 9-53 will be used to estimate settlement. A settlement near the upper bound in both figures will be selected as a conservative estimate.

A settlement of 0.15 percent of the diameter is selected for the average settlement of the sides, or 0.06-inch. That would indicate that about 138 tons is carried in side resistance, and about 12 tons is carried in bearing, assuming that the shaft is essentially incompressible.

Comment: The settlement solution appears to be reasonable.

### 9.12.7 Estimating Axial Capacity of Shafts in Rocks

Drilled shafts are commonly socketed into rock to limit axial displacements, increase load capacity and/or provide fixity for resistance to lateral loading.

Typically, axial compression load is carried solely by the side resistance on a shaft socketed into rock until a total shaft vertical displacement on the order of 0.4 inches occurs, i.e., elastic compression of the concrete plus downward movement of the shaft under load. At this displacement, the ultimate side resistance in rock,  $Q_{sr}$ , is mobilized and slip occurs between the concrete and rock. As a result of this slip, any additional load is transferred to the tip.

The design procedures assume the socket is constructed in reasonably sound rock that is not significantly affected by construction, i.e., the rock does not rapidly degrade upon excavation and/or exposure to air or water, and is cleaned prior to concrete placement, i.e., the rock surface is free of soil and other debris. If the rock is degradable, consideration of special construction procedures, larger socket dimensions, or reduced socket capacities should be considered.

#### 9.12.7.1 Side Resistance in Rocks

For drilled shafts socketed into rock, shaft resistance may be evaluated as follows (Horvath and Kenney, 1979):

$$Q_{sr} = \pi D_r L_r q_{sr} \quad 9-46$$

$$q_{sr} = 0.65(\alpha_E)(p_a) \left( \frac{q_u}{p_a} \right)^{0.5} < 0.65(p_a) \left( \frac{f'_c}{p_a} \right)^{0.5} \quad 9-47$$

where:  $D_r$  = diameter of rock socket (ft)  
 $L_r$  = length of rock socket (ft)  
 $q_{sr}$  = unit skin resistance of rock (tsf)  
 $q_u$  = uniaxial compressive strength of rock (tsf)  
 $p_a$  = atmospheric pressure = 1.06 tsf

$\alpha_E$  =  $E_M/E_i$  = reduction factor to account for jointing in rock as provided in Table 5-23 in Chapter 5, where  $E_M$  is the elastic modulus of the rock mass and  $E_i$  is the elastic modulus of intact rock

$f'_c$  = 28-day compressive strength of concrete (tsf)

Equation 9-46 applies to the case where the side of the rock socket is considered to be smooth or where the rock is drilled using a drilling slurry. Significant additional shaft resistance may be achieved if the borehole is specified to be artificially roughened by grooving. Methods to account for increased shaft resistance due to borehole roughness are provided in FHWA (1999).

Equation 9-46 should be used only for intact rock. When the rock is highly jointed, the calculated  $q_{sr}$  should be reduced to arrive at a final value for design. The procedure is as follows:

- Step 1. Evaluate the ratio of rock mass modulus to intact rock modulus (i.e.,  $E_m/E_i$ ) by using Table 5-23 in Chapter 5.
- Step 2. Evaluate the reduction factor,  $\alpha_E = E_M/E_i$ , by using Table 5-23.
- Step 3. Calculate  $q_{sr}$  according to Equation 9-47.

### 9.12.7.2 Tip Resistance in Rocks

If the rock below the base of the drilled shaft to a depth of 1.0 diameter is either intact or tightly jointed, i.e., there are no compressible materials or gouge-filled seams, and the depth of the socket is greater than 1.5 diameters, then the tip resistance of the rock may be evaluated as follows (FHWA, 1999):

$$Q_{tr} = A_t q_{tr} \quad 9-48$$

$$q_{tr} = 2.5 q_u \quad 9-49$$

where:  $A_t$  = tip area of rock socket

$q_{tr}$  = unit tip resistance, which is evaluated in terms of  $q_u$ , where  $q_u$  = unconfined compressive strength of intact rock (tsf)

If the rock below the base of the shaft is jointed and the joints have random orientation, then the reader should refer to the procedures in FHWA (1999).



### 9.12.8 Estimating Axial Capacity of Shafts in Intermediate GeoMaterials (IGMs)

Intermediate geomaterials (IGMs) are the transitory materials between soils and rocks. IGMs are defined by FHWA (1999) as follows:

- Cohesive IGM – clay shales or mudstones with an undrained shear strength,  $s_u$ , of 2.5 to 25 tsf, and
- Cohesionless – granular tills or granular residual soils with  $N_{60}$  greater than 50 blows/ft.

For detailed information regarding the estimation of shaft resistances in IGM's, the reader should consult FHWA (1999).

### 9.13 CONSTRUCTION METHODS FOR DRILLED SHAFTS

There are three basic methods for construction of drilled shafts. These are (a) dry method, (b) wet method and (c) casing method. Each of these methods is briefly presented below.

#### 1. Dry Method

The dry method is applicable to soils above the water table that will not cave or slump when the hole is drilled to its full depth. A soil that meets this specification is a homogeneous stiff clay. The dry method can be employed in some instances with sands above the water table if the sands have some cohesion, or if they will stand for a period of time because of apparent cohesion.

The dry method can be used for soils below the water table if the soils are low in permeability so that only a small amount of water will seep into the hole during the time the excavation is open.

The dry method consists of drilling a hole using an auger or bucket drill without casing, cleaning the bottom of the excavation, placing a rebar cage and then filling the hole with concrete. The 4 steps involved in construction of a drilled shaft by the dry method are shown in Figure 9-54.

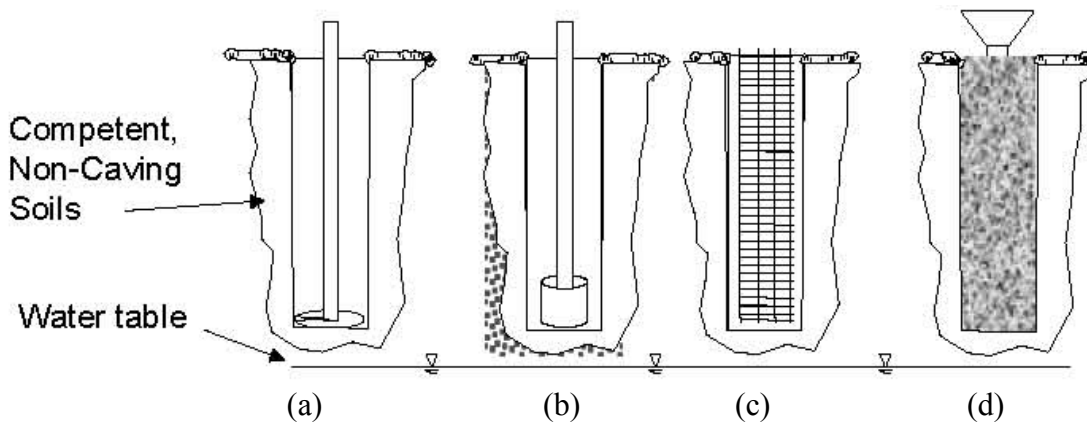

**Figure 9-54. Steps in construction of drilled shafts by the dry method (a) drill, (b) clean, (c) position reinforcement cage, and (d) place concrete.**

## 2. Wet Method

Bentonite or polymer slurry is introduced into the excavation to prevent caving or deformation of loose or permeable soils. The wet method is commonly used while drilling under the groundwater level. Drilling by use of an auger or clamshell mounted on a Kelly bar continues through the slurry. When the desired depth is reached, the excavation is cleaned and the rebar cage is lowered into the slurried hole. Concrete is then tremie-poured into the hole. Slurry is displaced by the heavier concrete and collected at the surface in a sump. The slurry may again be used in another hole. Figure 9-55 shows the 5-step process of shaft construction using wet method.

## 3. Casing Method

The casing method is applicable to sites where soil conditions are such that caving or excessive deformation will occur when a hole is excavated. An example of such a site is a clean sand below the water table. This method employs a cylindrical steel casing inside the excavation to support the caving soil. The excavation is made by driving, vibrating, or pushing a heavy casing to the proposed founding level and by removing the soil from within the casing either continuously as excavation proceeds or in one sequence after the casing has reached the desired depth. Slurry may be required if the excavation is advanced below the ground water table. The excavation is cleaned and the rebar cage is lowered into the excavation. Concrete is then placed, by tremie if the excavation is slurried, and the casing removed. The casing is sometimes permanently left in place. Figure 9-56 shows the 5-step process of shaft construction using the casing method.

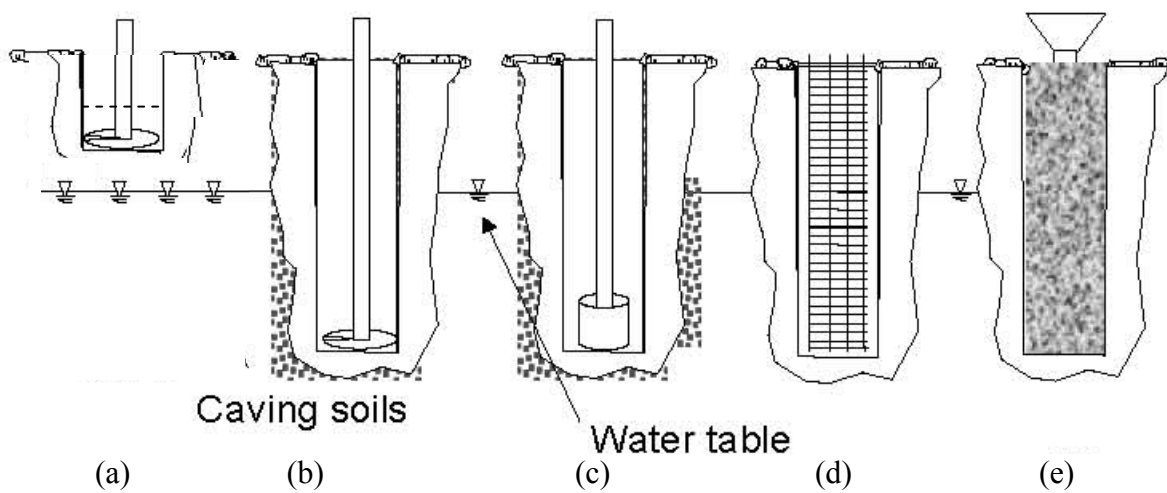

**Figure 9-55. Steps in construction of drilled shafts by the wet method (a) start drilling and introduce slurry (bentonite or polymer) in the excavation PRIOR to encountering the known piezometric level, (b) continue drilling with slurry in the excavation, (c) clean the excavation and slurry, (d) position reinforcement cage, and (e) place concrete by tremie.**

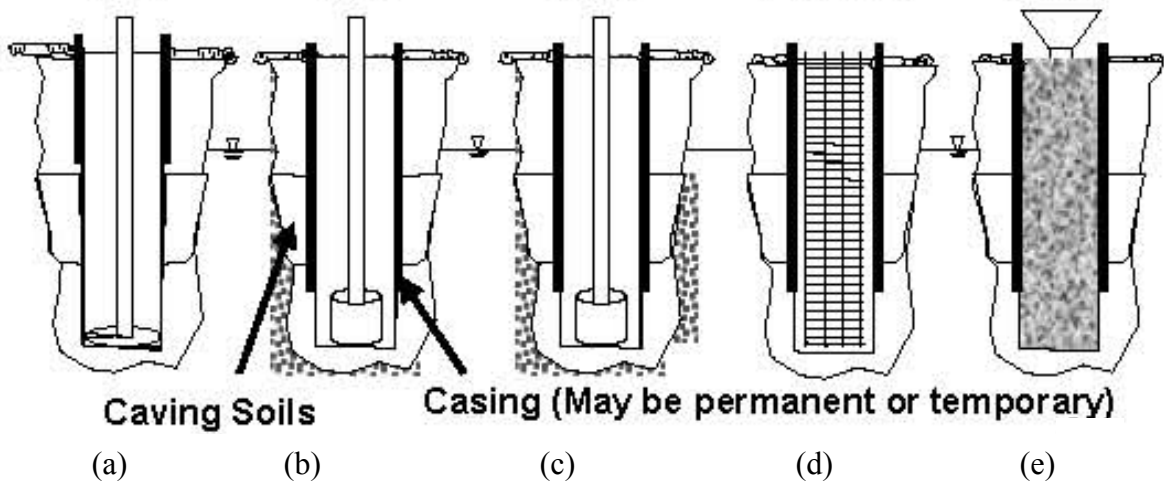

**Figure 9-56. Steps in construction of drilled shafts by the casing method (a) start drilling and introduce casing in the excavation PRIOR to encountering the known piezometric level and/or caving soil, (b) advance the casing through the soils prone to caving, (c) clean the excavation, (d) position reinforcement cage, and (e) place concrete and remove the casing if it is temporary.**

It is critical that the correct construction method be chosen for a given project. Unlike driven piles, which are assembled under controlled conditions and then driven into the ground, drilled shafts are “manufactured” on-site. Thus, the quality of the constructed drilled shaft will be only as good as the quality of the construction processes. In particular, the side and tip resistances are directly affected by the construction processes. While each of the steps in Figures 9-54 to 9-56 are important, **the most important step is related to cleaning of the shaft excavation. There are many considerations involved in the proper cleaning of shafts that are beyond the scope of this manual.** Figure 9-57a shows a photograph of a shaft in which the excavation was not cleaned properly, while Figure 9-57b shows a photograph of a shaft where the cleaning was adequate. These photographs clearly illustrate the need for proper cleaning of the shaft excavation. A detailed discussion of the drilled shaft construction and inspection processes including procedures to assure adequate cleaning can be found in FHWA (1999) and FHWA (2002d).



**Figure 9-57. Photographs of exhumed shafts (a) shaft where excavation was not adequately cleaned, (b) shaft where excavation was properly cleaned (FHWA, 2002d).**

## 9.14 QUALITY ASSURANCE AND INTEGRITY TESTING OF DRILLED SHAFTS

Unlike piles, which are manufactured in a factory (e.g., steel pipe piles) or a casting yard (e.g., precast concrete piles), drilled shafts are “manufactured” at the site. Anomalies often develop during the construction of drilled shafts as shown in Figure 9-57a. An anomaly is a deviation from an assumed uniform geometry of the shaft and/or from the required physical properties of the shaft. Typical anomalies may include necking or bulbing, “soft bottom” conditions, voids or soil intrusions, poor quality concrete, debonding, lack of concrete cover over the reinforcement steel and honey-combing. Non-destructive test (NDT) methods are used for Quality Assurance (QA) integrity testing of drilled shaft foundations to identify anomalies.

NDT testing techniques can be categorized as external and internal. External NDT techniques are used at the surface of the concrete structure when access to the interior of the concrete is not available. Examples of external NDT techniques include Sonic Echo (SE), Impulse Response (IR) or Ultra-seismic (US). Internal NDT techniques are used when testing equipment can access the interior of a concrete structure through either cast-in-place access tubes or cored access paths, or through cast-in-place equipment within the concrete (e.g., strain gages). **Commonly used internal NDT techniques include standard Cross-hole Sonic Logging (CSL) with zero-offset measurements and Gamma-Gamma Density Logging (GDL).** Both of these techniques are described below. Other more specialized internal NDT techniques include the Neutron Moisture Logging (NML) and Temperature Logging (TL). All of the NDT methods are discussed in FHWA (2003). Summaries of the methods are given in FHWA (1999), FHWA (2002d) and by Samtani, *et al.* (2005).

### 9.14.1 The Standard Crosshole Sonic Logging (CSL) Test

In the standard CSL test method, an ultrasonic transmitter or source and receiver probes are first lowered to the bottom of a pair of water-filled pre-installed access tubes as shown in Figure 9-58. It is common industry practice to locate the access tubes inside the reinforcing cage. The two probes are then pulled up simultaneously such that the probes are level with each other, i.e., zero-offset. The travel time of the ultrasonic wave between the tubes is recorded along with the amplitude of the signal as a function of every inch of depth. This test procedure is repeated for all possible paired combination of access tubes along the outer perimeter as well as across the inner diagonal of the shaft as shown in the inset Plan View in Figure 9-58. Typically, one tube per foot diameter of the shaft is installed for CSL tests. Thus, for 6-ft diameter shaft, 6 tubes are used. The minimum number of tubes should be 3.

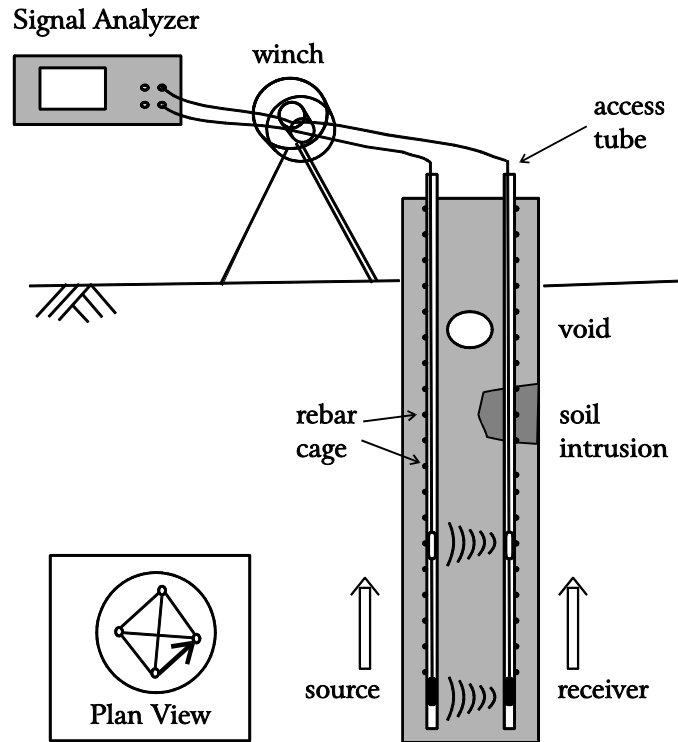

Figure 9-58. Schematic of CSL Test (Samtani, *et al.*, 2005).

The measured travel time,  $t$ , between two tubes with a known center to center distance,  $d$ , is expressed in terms of velocity as:  $V = d/t$ . This computed velocity,  $V$ , is compared with the theoretical compressional wave velocity,  $V_c$ , in concrete. The theoretical ultrasonic wave velocity in competent concrete with unconfined compressive strength,  $f'_c$ , in the range from 3,000 to 5,000 psi is approximately 10,000 to 11,500 ft/sec, respectively (Samtani *et al.*, 2005). As a comparison, the sonic velocity in water and air is approximately 5,000 ft/sec and 1,000 ft/sec, respectively. The computed velocity is compared with the theoretical velocity and expressed in terms of velocity reductions,  $VR = (1 - V/V_c)(100)\%$ . A qualitative rating is assigned to the concrete based on VR, as follows:

<u>VR</u>	<u>Rating</u>
0-10%	Good
10-20%	Questionable
>20%	Poor

The ratings are partially based on the estimated reduction in strength of concrete in anomalous zones. For example, if  $VR=10\%$  at a given location in a shaft, then the  $f'_c$  at that location is approximately 65% of the nominal 28-day  $f'_c$  value of the concrete in that shaft. Similarly, a concrete with  $VR=20\%$  implies that  $f'_c$  at that location is 40% of the 28-day strength.

With the exception of voids and possibly honeycombs, the locations of poor concrete can be confirmed by checking the signal amplitudes. Weaker concrete absorbs the energy of the sonic wave more than sounder concrete and this phenomenon is reflected in lower signal amplitudes. Thus, if the measurements in the shaft indicate lower velocity and lower signal amplitudes then they typically point to anomalous zones due to soil intrusions or poor quality concrete. An example single plot display format that includes velocity and signal amplitude profiles is shown in Figure 9-59. In this particular case, it can be seen that a soft bottom condition in the shaft is reflected at the very bottom of the profile by a drastic change in both in the velocity and amplitude profiles.

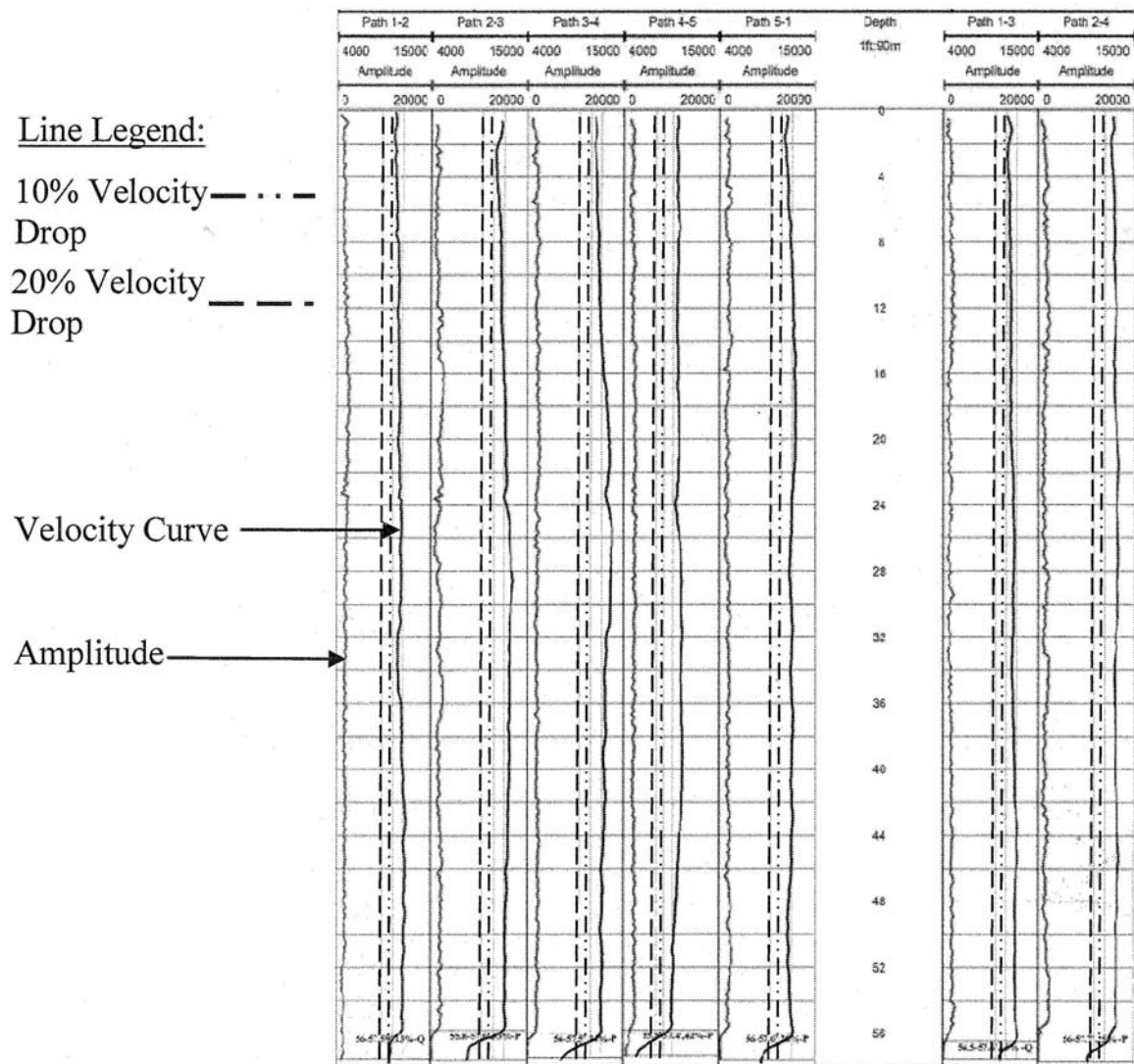

**Figure 9-59. Single plot display format for the CSL data for shaft with five tubes (Samtani, *et al.*, 2005).**

If the tubes debond from the concrete, i.e., there is a small air gap between the outer surface of the tube and the concrete of the shaft, then the CSL test will record a partial or complete loss of signal depending on the extent of the debonding around the perimeter of the tube at that location. Debonding can occur with Schedule 40 PVC access tubes particularly near the ground surface or above the groundwater table where temperature gradients are generally greater. For Schedule 40 PVC tubes, the debonding may occur within a week after placement of concrete as the concrete sets and tends to shrink away from the tubes. Thus, if Schedule 40 PVC tubes are used, then it is generally recommended to perform the CSL tests within 2 to 3 days after concrete placement. A thicker wall PVC tube, such as a Schedule 80 tube, may help extend this timeframe because it is able to withstand the higher temperature gradients better than a thinner PVC tube. Longer time frames can be achieved by the use of steel tubes that experience minimal to no debonding. Therefore, many owners tend to specify steel tubes to alleviate the debonding problems. However, in doing so, the owners are giving up an advantage of the PVC tubes in that they can serve as access paths to repair the shafts should an anomaly be identified by the CSL test since the PVC tubes can be cut open at any depth by use of a high velocity water jet, commonly known as the “water knife.” Use of a water knife is much more difficult, if not impossible, in steel due to the practical limitation of generating a very high water velocity at depth within the access tubes.

Cross-hole Sonic Logging Tomography (CSLT) using multi-offset CSL method is a logical newer extension of the CSL technique and is starting to gain acceptance. The Perimeter Sonic Logging (PSL) is yet another new variation in which zero-offset or multi-offset CSL may be performed in PVC tubes attached to the outside of the reinforcing cage. Samtani, *et al.* (2005) and FHWA (2003) provide summaries of these methods

#### **9.14.2 The Gamma Density Logging (GDL) Test**

A typical field setup for the GDL test is shown in Figure 9-60. In this test a weak Cesium-137 (radioactive) source emits gamma rays into the surrounding medium. A small fraction of the gamma ray photons are reflected back to the probe due to Compton scattering. The intensity of the reflected photons is recorded by a NaI scintillation crystal as counts per second (cps). The measured count rate (*cps*) depends on the electron density of the surrounding medium, which is proportional to the mass per unit volume. The instrument is calibrated by placing the probe in an environment of known density in order to convert the measured count rate (*cps*) into the units of density or unit weight, e.g. lb/ft<sup>3</sup> (pcf).

In the GDL test, the radius of the investigation is largely governed by ½ of the source-detector spacing. Good concrete conditions will result in a near continuous alignment of the data.



Anomalous zones due to soil intrusions, poor concrete or voids are characterized by low density which leads to a high count rate.

A typical GDL log is shown in Figure 9-61. In a GDL log, the measured gamma ray intensity count rate (cps) is presented in terms of unit weight (pcf). In Figure 9-61, the results are plotted in 4 separate sub-plots from the tested access tubes. Each individual sub-plot depicts the GDL results from a 14-inch source-detector separation (corresponding to about 5- to 6-inch radius of investigation) presented in a magnified density scale of 130-180 pcf. Also, in each sub-plot, the mean as well as the minus 2 (-2) and minus three (-3) standard deviation (SD) from mean curves are displayed as vertical guidelines. Depths, in feet, are measured from the top of the shaft and are shown on the vertical axis.

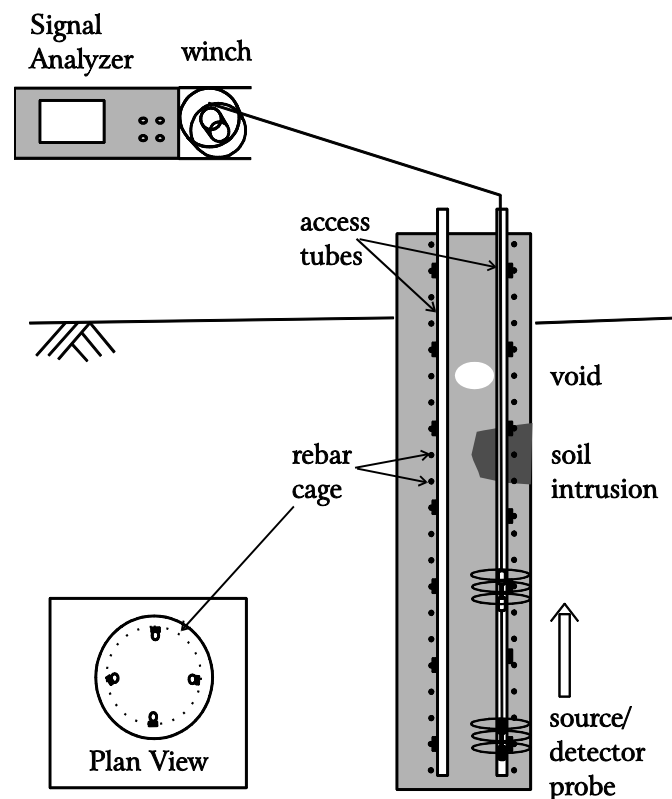
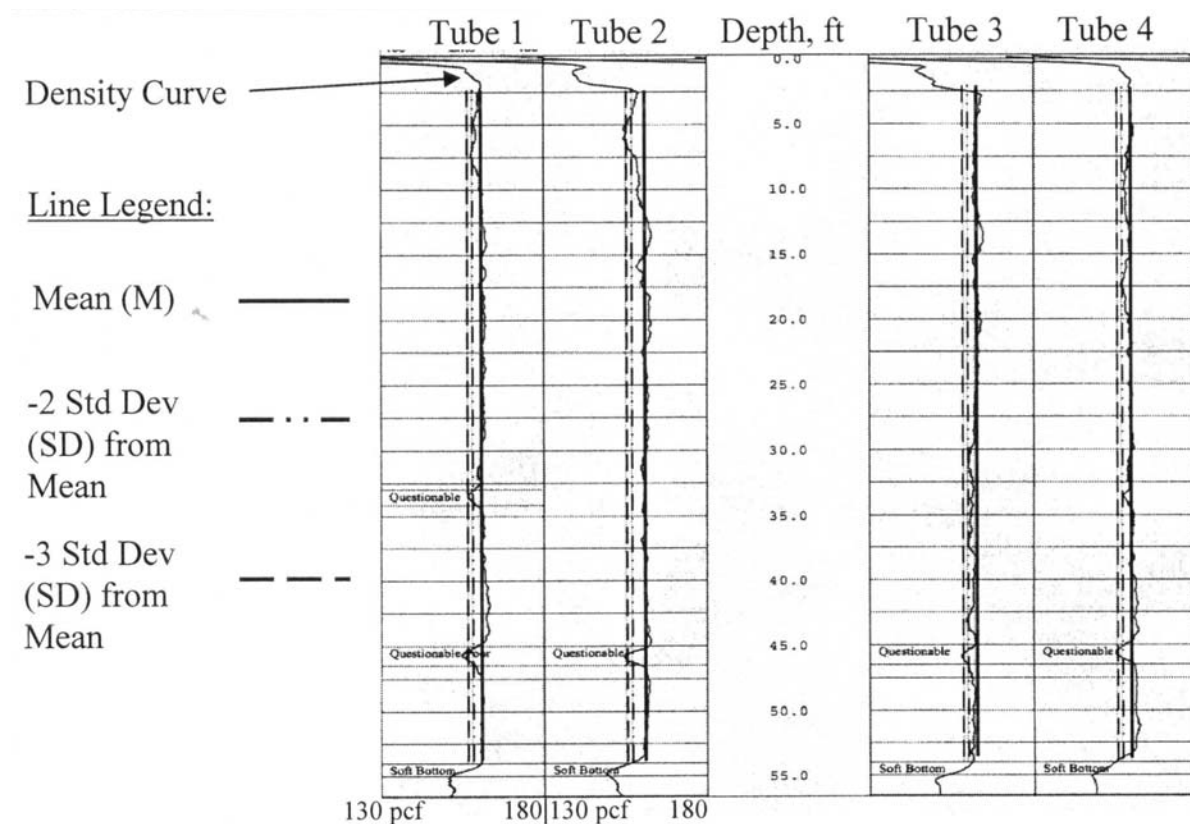

**Figure 9-60. Schematic of GDL Test (Samtani, *et al.*, 2005).**

The results of GDL tests are used to define “questionable” concrete conditions as a zone with reduction in unit weight between -2SD and -3SD and “poor” concrete conditions as a zone with reduction in unit weight of greater than -3SD from the mean (M). These criteria are based on the observation that a cps data set approximates a standard normal distribution probability function in which 99.73% of the data is within  $M \pm 3SD$ . Therefore, when data points are identified

beyond 3SDs, they are considered to represent an anomaly. While these definitions are generally accepted, it is not widely recognized that the computation of M and SD varies during presentation of the results by various testers/agencies. Some testers or agencies define the M and SD with respect to a given tube while others may define these quantities based on all tubes within a shaft, i.e. ignore the variation of steel density and hole geometry, or all tubes from a group of shafts that may form a single overall foundation element for a superstructure. Obviously, the definition of the concrete quality will be different based on the definition of the M and SD. Therefore, the user should be careful with the interpretation of the GDL test data.

Unlike the CSL test, the GDL is not affected much by debonding of the tubes from the concrete. Therefore, a PVC tube is generally used, although steel can also be used with GDL testing. It must be recognized, however, that the thicker or denser the tube material, the lower the measured counts per second (cps) since the tube itself will absorb some of the electrons. Therefore, the user of the data should review the calibration data and check whether the tube type used during calibration is consistent with that used in the actual shaft and the density of the shaft reinforcement.



**Figure 9-61. Single plot display format for the GDL data for shaft with four tubes (Samtani, *et al.*, 2005).**

### **9.14.3 Selecting the Type of Integrity Test for Quality Assurance**

Most agencies use either the CSL or GDL test method to evaluate the structural integrity of a constructed shaft. As shown in Figure 9-58, the CSL test evaluates the area of the shaft between the tubes. Since the tubes are commonly located on the inside of the cage, this means that only the portion of the shaft within the reinforcing cage is evaluated. On the other hand, the GDL test evaluates a portion of the shaft immediately surrounding a tube. In other words, GDL evaluates a zone inside and outside the reinforcing cage as shown in Figure 9-60. Due to the different portions of the shaft evaluated by the CSL and GDL tests, it is recommended that both tests be performed to assure an evaluation of the concrete inside and outside the reinforcing cage.

## **9.15 STATIC LOAD TESTING OF DEEP FOUNDATIONS**

Static load testing of deep foundations is the most accurate method of determining load capacity. Depending upon the size of the project, static load tests may be performed either during the design stage or the construction stage. Conventional load test types include the **axial compression, axial tension or lateral load tests**.

The purpose of this section is to provide an overview of static testing and its importance as well as to describe the basic test methods and interpretation techniques. For additional details on load testing for deep foundations, the reader is referred to FHWA (1992c) and ASTM D 1143. It may be noted that ASTM D 1143 was not re-approved in 2006. Therefore, as of the publication date of this manual, there is no accepted ASTM standard for static load tests. However, for the purposes of this manual, the latest ASTM D 1143 prior to 2006 is adequate from the viewpoint of the basic aspects of load testing.

### **9.15.1 Reasons for Load Testing**

1. To minimize risks to the structure by confirming the suitability of the deep foundation to support the design load with an appropriate factor of safety.
2. It is the most positive way for determining the capacity of deep foundations.
3. To develop information for use in the design and/or construction of a deep foundation.
4. Implementation of new static or dynamic analysis methods or procedures.
5. Calibrations of new design procedures such as the Load and Resistance Factor Design (LRFD).

### **9.15.2 Advantages of Static Load Testing**

The advantages of performing static load tests are summarized as follows:

1. A static load test allows a more rational design. Confirmation of pile-soil capacity through static load testing is considerably more reliable than capacity estimates from static capacity analyses and dynamic formulas.

2. An improved knowledge of deep foundation-soil behavior is obtained that may allow a reduction in deep foundations lengths or an increase in the design load, either of which may result in potential savings in foundation costs.
3. With the improved knowledge of deep foundation-soil behavior, a lower factor of safety may be used on the design load. A factor of safety of 2.0 is generally applied to design loads confirmed by load tests as compared to a factor of safety of 3.5 used on design loads in the Modified Gates dynamic formula. Hence, a cost savings potential again exists (Refer to Table 9-5).
4. The ultimate geotechnical capacity determined from load testing allows confirmation that the design load may be adequately supported at the planned foundation penetration depth.

Engineers are sometimes hesitant to recommend a static load test because of cost concerns or potential time delays in design or construction. While the cost of performing a static load test should be weighed against the anticipated benefits, cost alone should not be the determining factor.

Delays to a project in the design or construction stage usually occur when the decision to perform static load tests is added late in the project. Such delays can be minimized by determining early in the project whether a static load test program should be performed. In the construction stage, delays can be minimized by clearly specifying the number and locations of static load tests to be performed as well as the time necessary for the engineer to review the results. In addition, the specifications should state that the static test must be performed prior to ordering pile lengths or commencing production driving. In this way, the test results are available to the design and construction engineer early in the project so that the maximum benefits can be obtained. At the same time the contractor is also aware of the test requirements and analysis duration and can schedule the project accordingly.

### **9.15.3 When to Load Test**

The following criteria, adapted and modified from FHWA (1992c), summarize conditions when pile load testing can be effectively utilized:

1. When substantial cost savings can be realized. This is often the case on large projects involving either friction piles to prove that lengths can be reduced or end bearing piles to prove that the design load can be increased. Testing can also be justified if the savings obtained by using a lower factor of safety equals or exceeds the testing cost.

2. When a safe design load is uncertain due to limitations of an engineer's experience base or due to unusual site or project conditions.
3. When subsurface conditions vary considerably across the project, but can be delineated into zones of similar conditions. Static tests can then be performed in representative areas to delineate foundation variation.
4. When a significantly greater load is contemplated relative to typical design loads and practice.
5. When time dependent changes in deep foundation capacity are anticipated as a result of soil setup or relaxation.
6. Verification of new design or testing methods.
7. When new, unproven deep foundation types and/or pile installation procedures are utilized.
8. When existing deep foundations will be reused to support a new structure with heavier design loads.
9. When a reliable assessment of uplift capacity or lateral behavior is important.
10. When, during construction, the estimated ultimate capacity determined by using dynamic formulas or dynamic analysis methods differs from the estimated capacity at that depth determined by static analysis. For example, H-piles that "run" when driven into loose to medium dense sands and gravels.
11. Calibrations of new design procedures such as the Load and Resistance Factor Design (LRFD).

Experience has also shown that load tests will typically confirm that pile lengths can be reduced at least 15 percent versus the lengths that would be required by the Engineering News (EN) formula on projects where piles are supported predominantly by shaft resistance. This 15 percent pile length reduction was used to establish the following "rule of thumb" formula to compute the total estimated pile length that the project must have to make the load test cost effective based purely on material savings alone.

$$\text{Total estimated pile length in feet on project} \geq \frac{\text{cost of load test}}{(0.15) (\text{cost / ft of pile})} \quad 9-50$$

The above formula may not be valid for drilled shafts since the EN formula is not applicable.

#### **9.15.4 Effective Use of Load Tests**

##### **9.15.4.1 Design Stage**

The best information for design of a deep foundation is provided by the results of a load testing program conducted during the design phase. The number of static tests, types of piles/shafts to be tested, method of driving and test load requirements, method of shaft excavation should be selected by the geotechnical and structural engineers responsible for design. A cooperative effort between the two is necessary. The following are the advantages of load testing during the design stage.

- a. Allows load testing of several different pile/shaft types and lengths resulting in the design selection of the most economical pile/shaft foundation.
- b. Confirm driveability to minimum penetration requirements and suitability of foundation capacity at estimated pile penetration depths.
- c. Establishes preliminary driving criteria for production piles.
- d. Pile driving information released to bidders should reduce their bid "contingency."
- e. Confirm the excavation and excavation support methods for drilled shafts.
- e. Reduces potential for claims related to pile driving problems or shaft excavation methods.
- f. Allows the results of the load test program to be reflected in the final design and specifications.

##### **9.15.4.2 Construction Stage**

Load testing at the start of construction may be the only practical time for testing on smaller projects that can not justify the cost of a design stage program. Construction stage static tests are invaluable to confirm that the design loads are appropriate and that the pile installation procedure

is satisfactory. Driving of test piles and load testing is frequently done to determine the pile order length at the beginning of construction. These results refine the estimated pile lengths shown on the plans and establish minimum pile penetration requirements.

### **9.15.5 Prerequisites for Load Testing**

In order to plan and implement a static load testing program adequately, the following information should be obtained or developed.

1. A detailed subsurface exploration program at the test location. A load test is not a substitute for a subsurface exploration program.
2. Well defined subsurface stratigraphy including engineering properties of soil materials and identification of groundwater conditions.
3. Static pile capacity analyses to select pile type(s) and length(s) as well as to select appropriate location(s) for load test(s).
4. For drilled shafts, caliper-logging to determine the exact dimensions of the shaft excavation. Caliper-logging is required because the actual dimensions of excavations in geomaterials can vary significantly from the diameter of the drilling tool due to a variety of geologic factors or drilling considerations. Calipers are available in either mechanical or electronic configurations. Determination of the exact dimensions of the excavation is the key to proper interpretation of the load test results.
5. For drilled shafts, integrity testing should be performed prior to the load test to determine whether the shaft needs to be structurally repaired so that it has enough structural capacity to sustain the test loads.

### **9.15.6 Developing a Static Load Test Program**

The goal of a static load test program should be clearly established. The type and frequency of tests should be selected to provide the required knowledge for final design purposes or construction verification. A significantly different level of effort and instrumentation is required if the goal of the load test program is simply to confirm the ultimate pile capacity or if detailed load-transfer information is desired for final design. The following items should be considered during the planning stage of the load test program so that the program provides the desired information.



1. The capacity of the loading apparatus (reaction system and jack) should be specified so that the test pile(s) may be loaded to plunging failure. A loading apparatus designed to load a pile to only twice the design load is usually insufficient to obtain plunging failure. Hence, the true factor of safety on the design load cannot be determined, and the full benefit from performing the static test is not realized.
2. Specifications should require use of a load cell and spherical bearing plate as well as dial gages with sufficient travel to allow accurate measurements of load and movement at the pile head. Where possible, deformation measurements should also be made at the pile toe and at intermediate points to allow for an evaluation of shaft and toe bearing resistance.
3. The load test program should be supervised by a person experienced in this field of work.
4. A test pile installation record should be maintained with installation details appropriately noted. Too often, only the hammer model and driving resistance are recorded on a test pile log. Additional items such as hammer stroke (particularly at final driving), fuel setting, accurately determined final set, installation aids used and depths at which they are used, predrilling, driving times, stops for splicing, etc., should be recorded.
5. Use of dynamic monitoring equipment on the load test pile is recommended for estimates of pile capacity at the time of driving, evaluation of drive system performance, calculation of driving stresses, and subsequent refinement of soil parameters for wave equation analysis.

### **9.15.7 Compression Load Tests**

Deep foundations are most often tested in compression, but they can also be tested in tension or for lateral load capacity. Figure 9-62 illustrates the basic mechanism of performing a compression pile load test. This mechanism normally includes the following steps:

1. The pile is loaded incrementally from the pile head according to some predetermined loading sequence, or it can be loaded at a continuous, constant rate.
2. Measurements of load, time, and movement at the pile head and at various points along the pile shaft are recorded during the test.
3. A load movement curve is plotted.

4. The failure load and the movement at the failure load are determined by one of several methods of interpretation.
5. The movement is usually measured only at the pile head. However, the pile can be instrumented to determine movement anywhere along the pile. Telltales (solid rods protected by tubes) shown in Figure 9-62 or strain gages may be used to obtain this information.

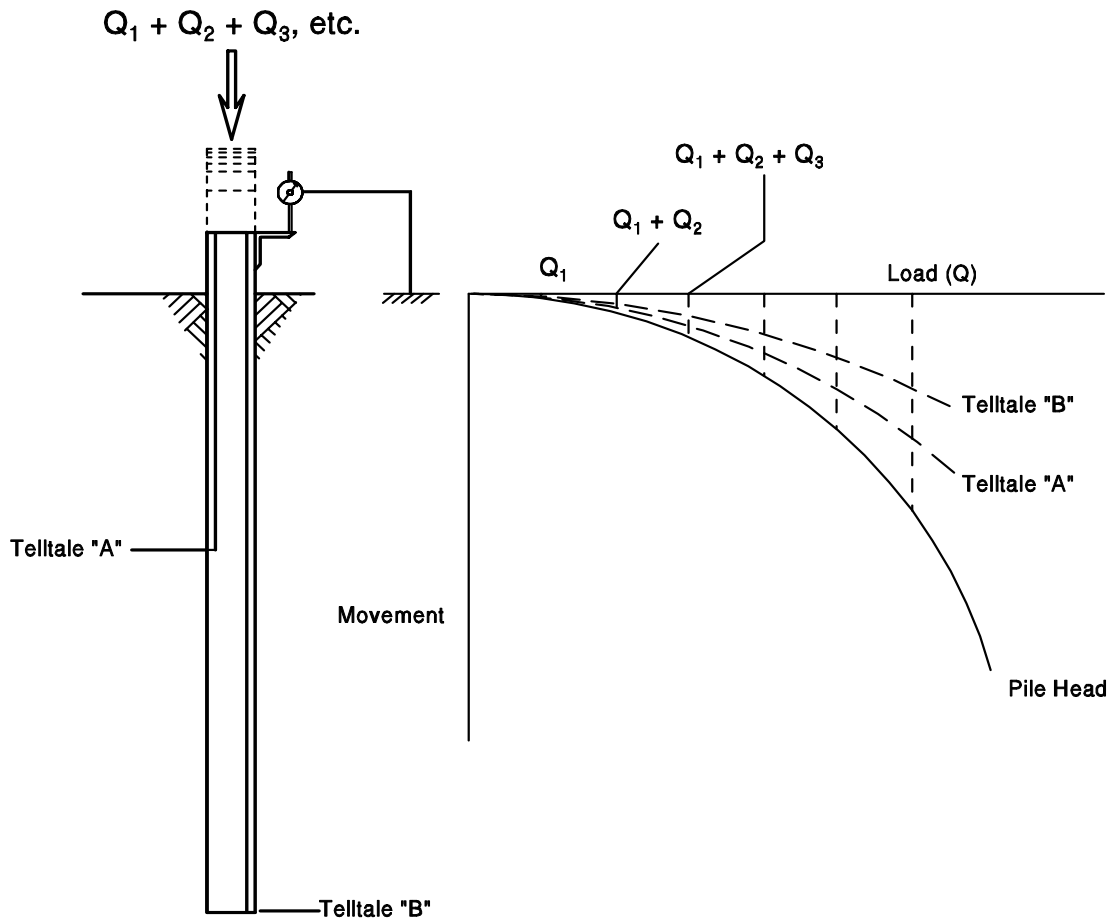

**Figure 9-62. Basic mechanism of a compression pile load test (FHWA, 2006a).**

### 9.15.7.1 Compression Test Equipment

ASTM D1143 recommends several alternative systems for (1) applying compressive load to the pile, and (2) measuring movements. Most often, compressive loads are applied by hydraulically jacking against a beam that is anchored by piles or ground anchors, or by jacking against a weighted platform. A schematic of a typical compression load test setup is presented in Figure 9-63. The primary means of measuring the load applied to the pile should be with a calibrated load cell. The jack load should also be recorded from a calibrated pressure gage, such as the Bourdon gage shown in Figure 9-63. To minimize eccentricities in the applied load, a spherical bearing plate should be included in the load application arrangement.

Axial pile or shaft head movements are usually measured by dial gages or LVDT's that measure movement between the pile head and an independently supported reference beam. ASTM requires the dial gages or LVDT's have a minimum of 2 inches (50 mm) of travel and a precision of at least 0.01 inches (0.25 mm). It is preferable to have gages with a minimum travel of 3 inches (75 mm) and with a precision of 0.001 inches (0.025 mm) particularly when testing long piles that may undergo large elastic deformations under load. A minimum of two dial gages or LVDT's mounted equidistant from the center of the pile and diametrically opposite to each other should be used. Two backup systems consisting of a scale, mirror, and wire system should be provided with a scale precision of 0.01 inches (0.25 mm). The backup systems should also be mounted on diametrically opposite pile faces. Both the reference beams and backup wire systems are to be independently supported with a clear distance of not less than 8 ft (2.5 m) between supports and the test pile. A remote backup system consisting of a survey level should also be used in case reference beams or wire systems are disturbed during the test.

ASTM D 1143 specifies that the clear distance between a test pile and reaction piles be at least 5 times the maximum diameter of the reaction pile or test pile, whichever has the greater diameter if not the same pile type, but not less than 7 ft (2 m). If a weighted platform is used, ASTM D 1143 requires the clear distance between the cribbing supporting the weighted platform and the test pile exceed 5 ft (1.5 m).

Photographs of the load application and movement monitoring components are presented in Figures 9-64 and 9-65. A typical compression load test arrangement using reaction piles is presented in Figure 9-66 and a weighted platform arrangement is shown in Figure 9-67. Additional details on load application as well as head load and movement measurements may be found in ASTM D1143 as well as in FHWA (1992c).

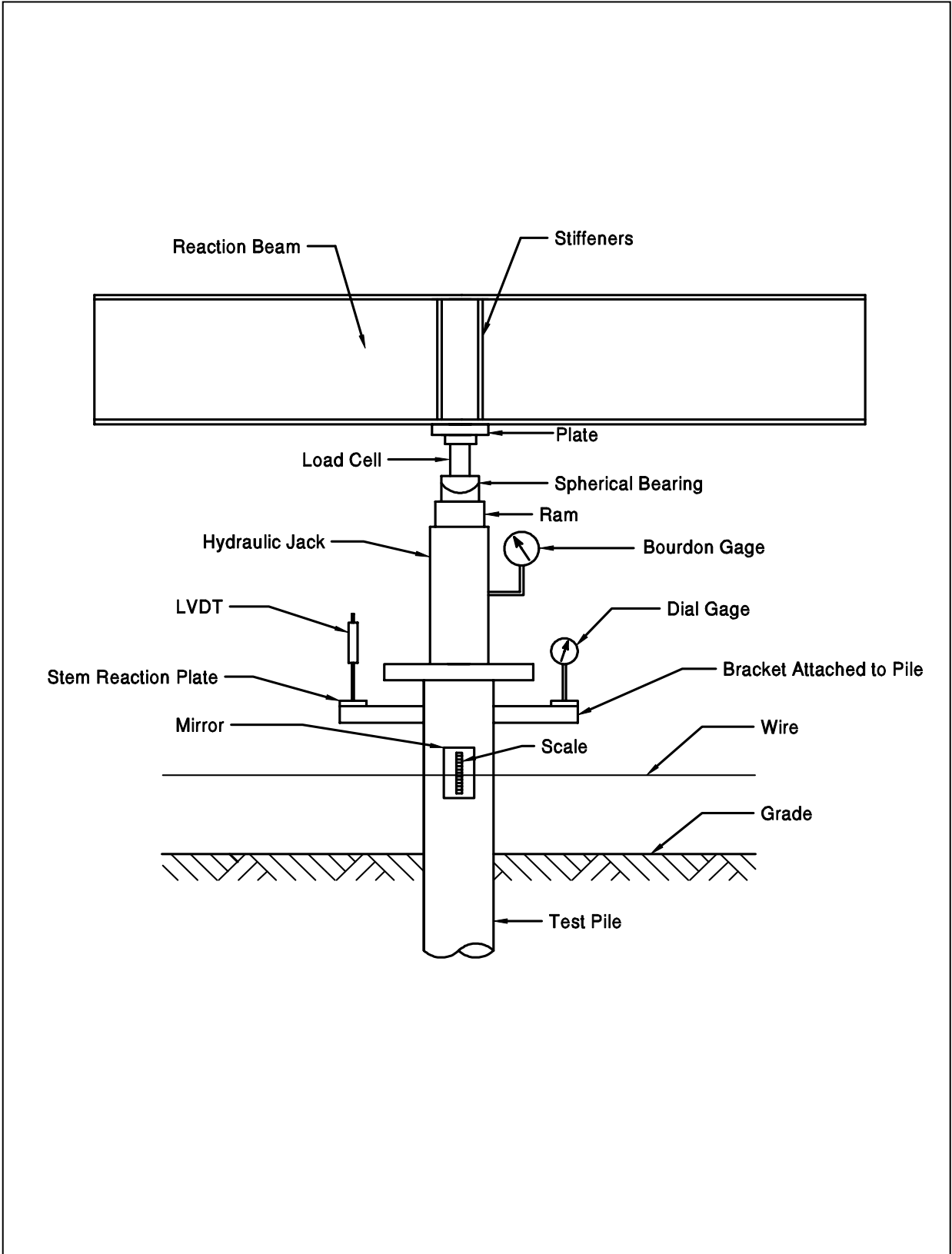

**Figure 9-63. Typical arrangement for applying load in an axial compressive test (FHWA, 1992c).**

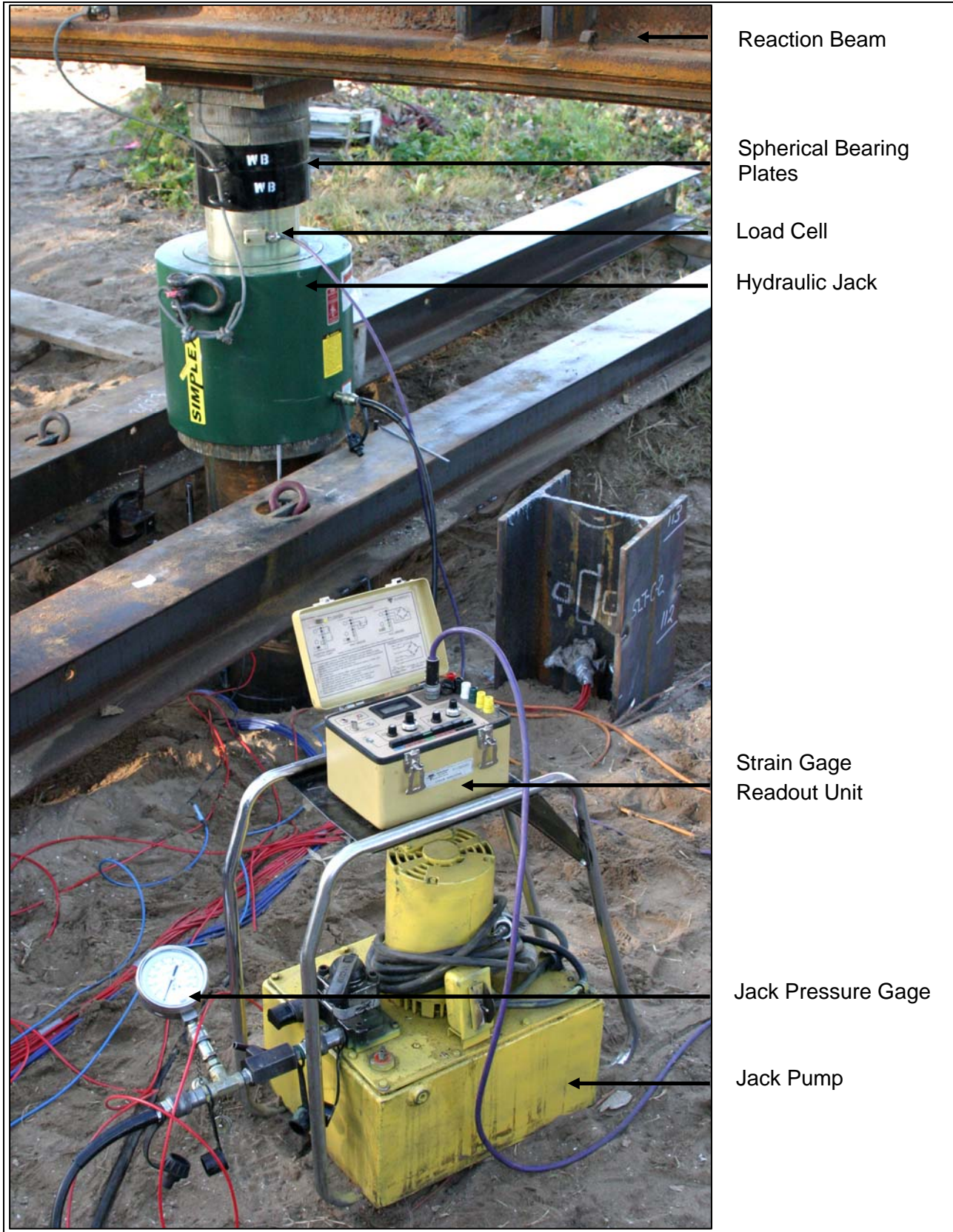

**Figure 9-64. Load test load application and monitoring components (FHWA, 2006a).**



**Figure 9-65. Load test movement monitoring components (FHWA, 2006a).**

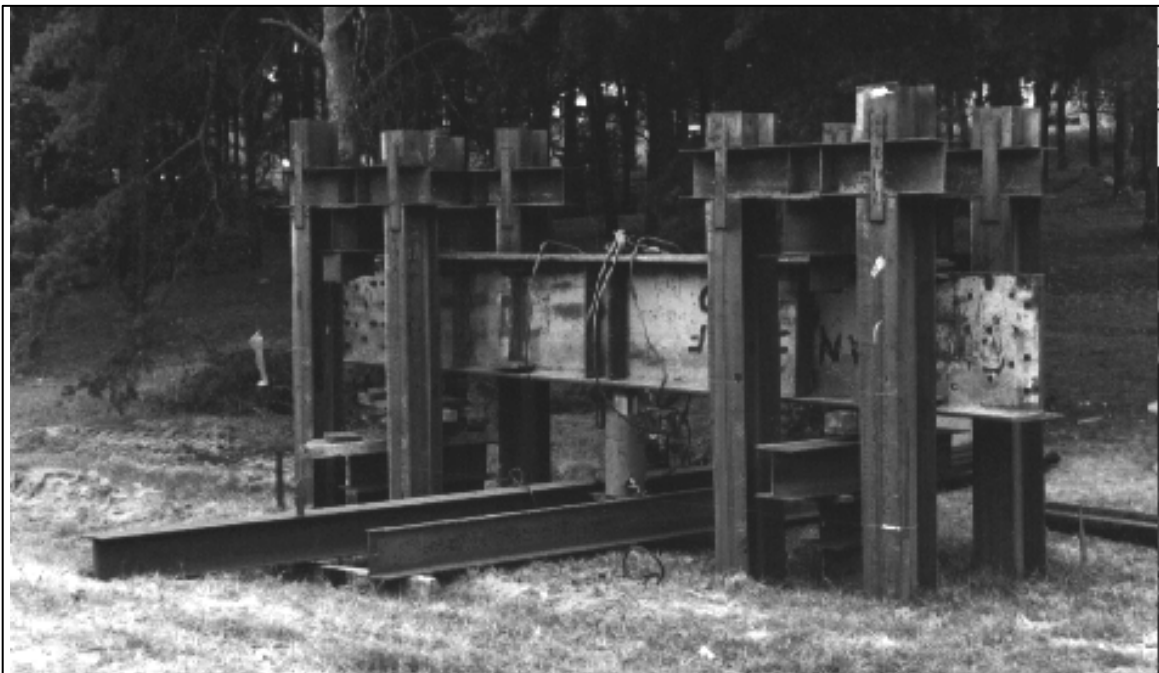

**Figure 9-66. Typical compression load test arrangement with reaction piles (FHWA, 2006a).**



**Figure 9-67. Typical compression load test arrangement using a weighted platform (FHWA, 2006a).**

### **9.15.7.2 Recommended Compression Test Loading Method**

It is extremely important that standardized load testing procedures are followed. Several loading procedures are detailed in ASTM D 1143. The quick load test method is recommended. This method replaces traditional methods where each load increment was held for extended periods of time. The quick test method requires that load be applied in increments of 10 to 15% of the pile design load with a constant time interval of 2½ minutes or as otherwise specified between load increments. Readings of time, load, and gross movement are to be recorded immediately before and after the addition of each load increment. This procedure is to continue until continuous jacking is required to maintain the test load or the capacity of the loading apparatus is reached, whichever occurs first. Upon reaching and holding the maximum load for 5 minutes, the pile is unloaded in four equal load decrements, each of which is held for 5 minutes. Readings of time, load, and gross movement are once again recorded immediately after, 2½ minutes after, and 5 minutes after each load reduction, including the zero load.

### **9.15.7.3 Presentation and Interpretation of Compression Test Results**

The results of load tests should be presented in a report conforming to the requirements of ASTM D 1143. A load-movement curve similar to the one shown in Figure 9-68 should be plotted for interpretation of test results.

The literature abounds with different methods of defining the failure load from static load tests. Methods of interpretation based on maximum allowable gross movements, which do not take into account the elastic deformation of the pile shaft, are not recommended. These methods overestimate the allowable capacities of short piles and underestimate the allowable capacities of long piles. Methods that account for elastic deformation and are based on a specified failure criterion provide a better understanding of pile performance and provide more accurate results.

AASHTO (2002) and FHWA (1992c) recommend pile compression test results be evaluated by using an offset limit method as proposed by Davisson (1972). The “double-tangent” is more commonly used for drilled shafts. These methods are shown in Figure 9-68 and are discussed in the following sections.



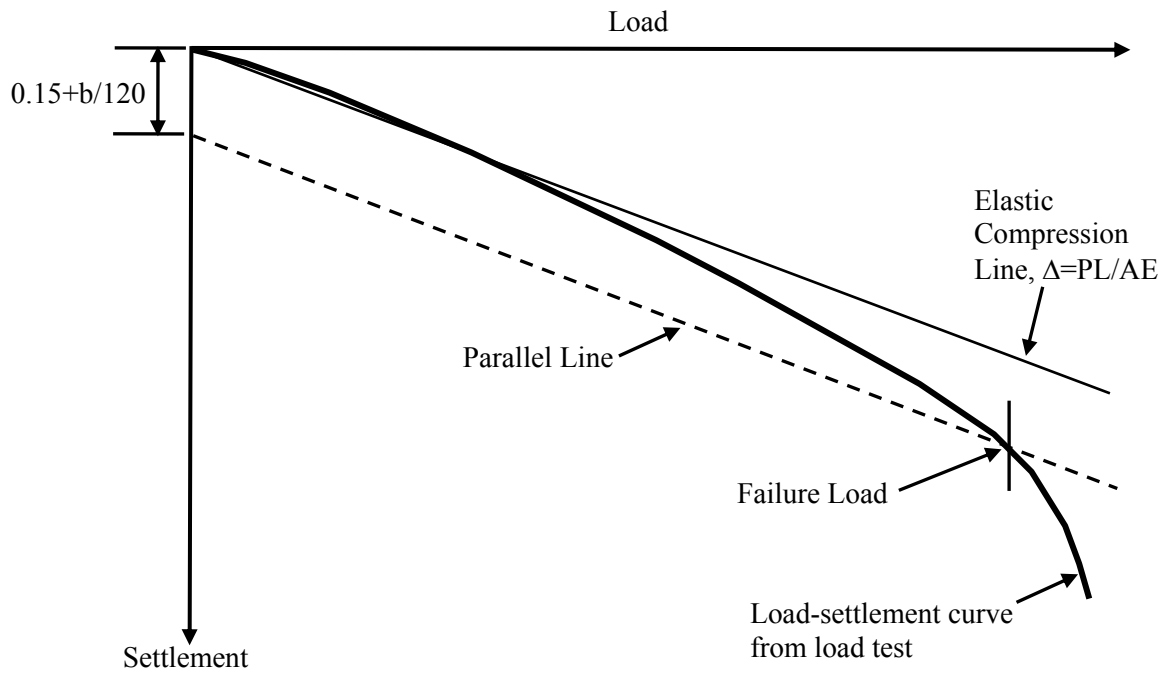

(a)

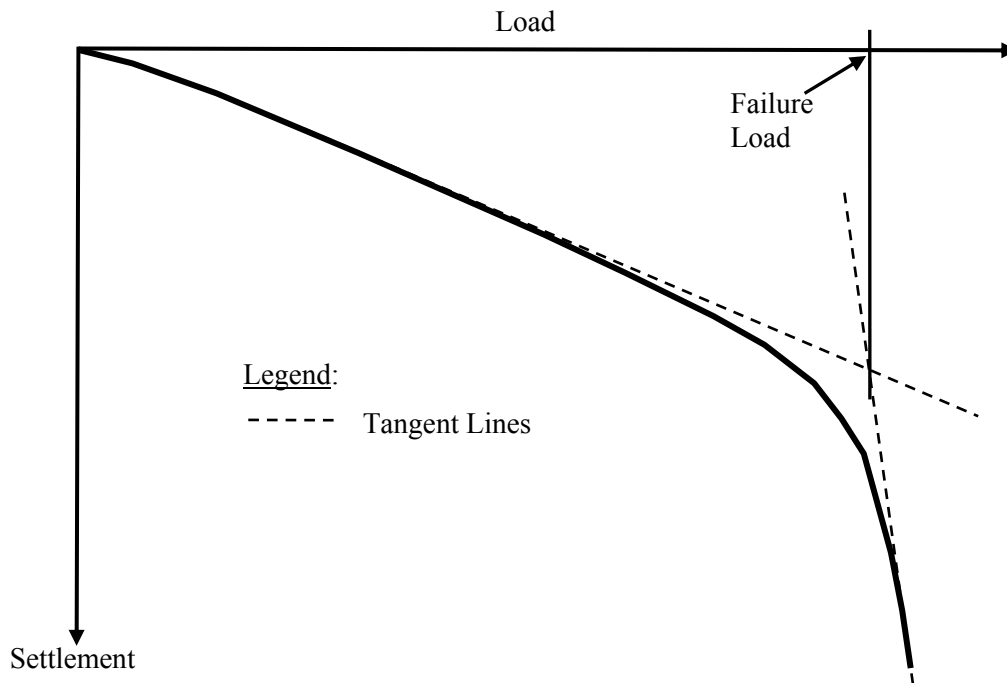

(b)

**Figure 9-68. Presentation of typical static pile load-movement results, (a) Davisson's method, (b) Double-tangent method.**

#### 9.15.7.4 Plotting the Failure Criteria

Figure 9-68a shows the load-movement curve from a typical pile load test. To facilitate the interpretation of the test results, the scales for the loads and movements are selected so that the line representing the elastic deformation  $\Delta$  of the pile is inclined at an angle of about  $20^\circ$  from the load axis. The elastic deformation  $\Delta$  is computed from:

$$\Delta = \frac{QL}{AE} \quad 9-51$$

Where:  $\Delta$  = elastic deformation in inches (mm)  
Q = test load in kips (kN)  
L = pile length in inches (mm)  
A = cross sectional area of the pile in  $\text{in}^2$  ( $\text{m}^2$ )  
E = modulus of elasticity of the pile material in ksi (kPa)

#### 9.15.7.5 Determination of the Ultimate (Failure) Load

For pile diameters less than 24 in (610 mm), the ultimate or failure load  $Q_f$  of a pile is that load which produces a movement of the pile head equal to:

$$\text{In US Units} \quad s_f = \Delta + \left( 0.15 + \frac{b}{120} \right) \quad 9-52$$

where:  $s_f$  = settlement at failure in inches  
b = pile diameter or width in inches  
 $\Delta$  = elastic deformation of total pile length in inches

A failure criterion line parallel to the elastic deformation line is plotted as shown in Figure 9-68a. The point at which the observed load-movement curve intersects the failure criterion is by definition the failure load. If the load-movement curve does not intersect the failure criterion line, the pile has an ultimate capacity in excess of the maximum applied test load.

For pile diameters greater than 24 in (610 mm), additional pile toe movement is necessary to develop the toe resistance. For pile diameters greater than 24 in (610 mm), the failure load can be defined as the load that produces at movement at the pile head equal to:

*In US Units*

$$s_f = \Delta + \left( \frac{b}{30} \right)$$

9-53

For drilled shafts, the failure load is commonly determined based on the “double-tangent” method shown in Figure 9-68b. Alternatively, the failure load is often defined as the test load corresponding to 5% of the shaft diameter because such a movement represents a large movement given that the drilled shafts are often much larger in diameter than driven piles.

### **9.15.7.6 Determination of the Allowable Geotechnical Load**

The allowable geotechnical load is usually determined by dividing the ultimate load,  $Q_u$ , by a suitable factor of safety. A factor of safety of 2.0 is recommended by AASHTO (2002) and is often used. However, larger factors of safety may be appropriate under the following conditions:

- a. Where soil conditions are highly variable.
- b. Where a limited number of load tests are specified.
- c. For friction piles in clay, where group settlement may control the allowable load.
- d. Where the total movement that can be tolerated by the structure is exceeded.
- e. For piles installed by means other than impact driving, such as vibratory driving or jetting.

### **9.15.7.7 Load Transfer Evaluations**

FHWA (1992c) provides a method for evaluation of the soil resistance distribution from telltales embedded in a load test pile. The average load in the pile,  $Q_{avg}$ , between two measuring points can be determined as follows:

$$Q_{avg} = A E \frac{R_1 - R_2}{\Delta L} \quad 9-54$$

- Where:
- $\Delta L$  = length of pile between two measuring points under no load condition
  - A = cross sectional area of the pile
  - E = modulus of elasticity of the pile
  - $R_1$  = deflection readings at upper of two measuring points
  - $R_2$  = deflection readings at lower of two measuring points

If the  $R_1$  and  $R_2$  readings correspond to the pile head and the pile toe respectively, then an estimate of the shaft and toe resistances may be computed. For a pile with an assumed constant uniform soil resistance distribution, Fellenius (1990) states that an estimate of the toe resistance,  $R_t$ , can be computed from the applied pile head load,  $Q_h$  by the following equation.

$$R_t = 2 Q_{avg} - Q_h \quad 9-55$$

The applied pile head load,  $Q_h$ , is chosen as close to the failure load as possible. For a pile with an assumed linearly increasing triangular soil resistance distribution, the estimated toe resistance may be calculated by using the following equation:

$$R_t = 3 Q_{avg} - 2 Q_h \quad 9-56$$

The estimated shaft resistance can then be calculated from the applied pile head load minus the toe resistance.

During driving, residual loads can be locked into a pile that does not completely rebound after a hammer blow, i.e., return to a condition of zero stress along its entire length. This mechanism is particularly true for flexible piles, piles with large frictional resistances, and piles with large toe quakes. Load transfer evaluations performed by using telltale measurements described above assume that no residual loads are locked in the pile during driving. Therefore, the load distribution calculated from the above equations would not include residual loads. If measuring points  $R_1$  and  $R_2$  correspond to the pile head and pile toe of a pile that has locked-in residual loads, the calculated average pile load would also include the residual loads. This inclusion of residual loads would result in a lower toe resistance being calculated than actually exists as depicted in Figure 9-69. Additional details on telltale load transfer evaluation, including residual load considerations, may be found in Fellenius (1990).

When detailed load transfer data is desired, telltale measurements alone are insufficient since residual loads cannot be directly accounted for. Dunncliff (1988) suggests that weldable vibrating wire strain gages be used on steel piles and sister bars with vibrating wire strain gages be embedded in concrete piles for detailed load transfer evaluations. A geotechnical instrumentation specialist should be used to select the appropriate instrumentation to withstand pile handling and installation, to determine the redundancy required in the instrumentation system, to determine the appropriate data acquisition system, and to reduce and report the data acquired from the instrumentation program.

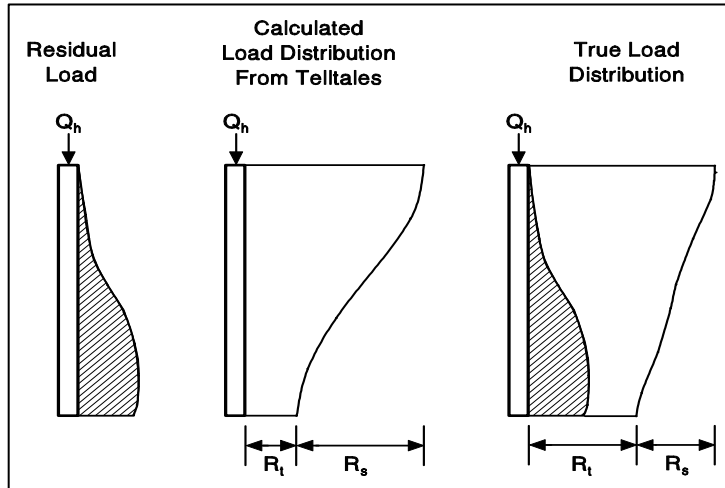
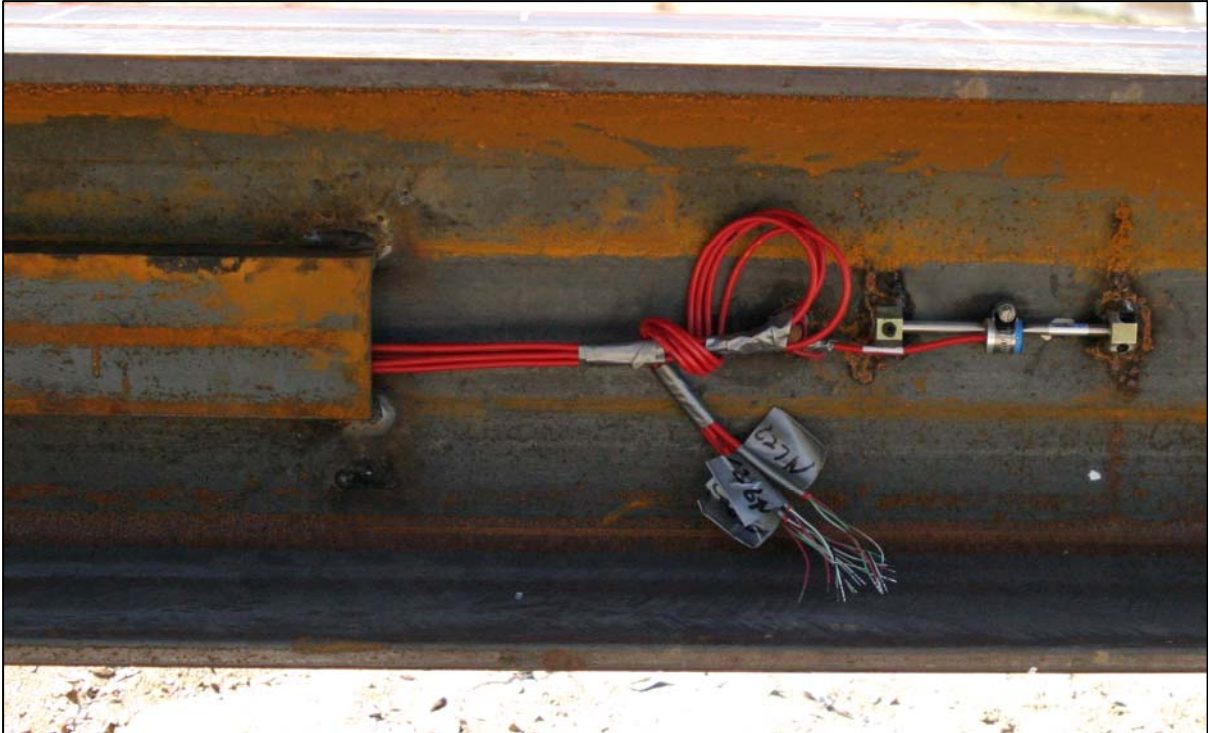

**Figure 9-69. Example of residual load effects on load transfer evaluation (FHWA, 2006a).**

A sister bar vibrating wire strain gage for embedment in concrete or concrete filled pipe piles is shown in Figure 9-70 and an arc-weldable vibrating wire strain gage attached to a steel H-pile is presented in Figure 9-71. When detailed load-transfer data is desired, a data acquisition system should be used.



**Figure 9-70. Sister bar vibrating wire gages for concrete embedment (FHWA, 2006a).**



**Figure 9-71. Arc-weldable vibrating wire strain gage attached to H-pile. (Note: protective channel cover shown on left) (FHWA, 2006a).**

### **9.15.8 Other Compression Load Tests**

Two methods of load testing were introduced in recent years that have been used to varying degrees by highway agencies for testing drilled shafts. These methods are the Osterberg Cell<sup>®</sup> and the Statnamic<sup>®</sup> methods, both of which are proprietary methods. Both of these techniques can routinely be used for test loads in range of 10,000 to 15,000 kips. The Osterberg Cell<sup>®</sup> test can apply loads up to 50,000 kips. Both, driven piles and cast-in-place piles, e.g., drilled shafts, can be tested by these methods. Although the details of each method are beyond the scope of this manual, a brief description follows on each method. Additional details are presented in primary references for this chapter (FHWA, 2006a; FHWA, 1999).

#### **9.15.8.1 The Osterberg Cell<sup>®</sup> Method**

Instead of using a conventional jack, reaction frame and reaction anchor system, the axial loading test can be performed by applying the load with an expendable jack and load cell cast within the test shaft. This jack - load cell is called an Osterberg Cell<sup>®</sup> after its inventor, Jorj Osterberg and the test in which the Osterberg Cell<sup>®</sup> is used is commonly known as the O-Cell<sup>®</sup> test. A schematic of the O-Cell<sup>®</sup> test in comparison with a static load test with a

reaction frame is shown in Figure 9-72. Figure 9-73 shows some details for the O-Cell<sup>®</sup> test. Figure 9-74 shows a photograph of an O-cell. Figure 9-75 shows a photograph of an O-Cell<sup>®</sup> assembly attached to a reinforcing cage just prior to the cage being placed into a drilled shaft excavation.

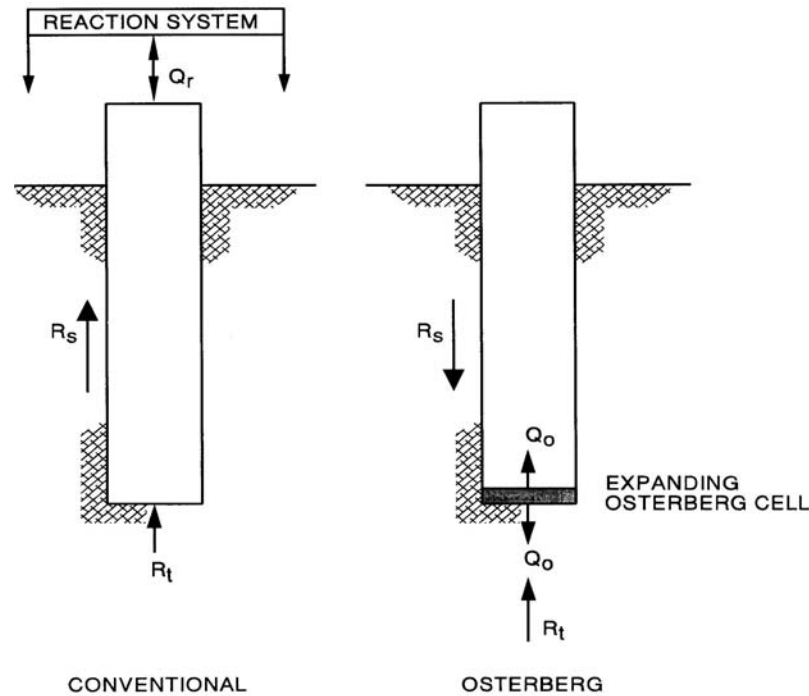

**Figure 9-72. Comparison of reaction mechanism between Osterberg Cell<sup>®</sup> and Static test.**

The principle of operation is very simple. The Osterberg Cell<sup>®</sup> consists essentially of two plates (pistons) of a prescribed diameter between which there is an expandable chamber that can hold pressurized fluid, usually oil or water. The upper and lower plates on the cell can be field welded to steel plates, usually at least 2 in (50 mm) thick, whose diameters are approximately equal to that of the test shaft. The chamber is pressurized by pumping from a reservoir on the ground surface. The unique feature of this device is that the pistons being pressurized have standard diameters that are approximately the full diameter of the cell, which may be up to 32 in (800 mm). Therefore, the pressurized fluid is acting on a very large area, unlike a conventional ram in which the area of the piston is usually small. This characteristic allows the Osterberg Cell<sup>®</sup> to apply very large loads with relatively low hydraulic pressures. Standard models with a diameter of 32 in (800 mm) are capable of applying loads of up to 3,000 tons (26.7 MN). Smaller sizes are also available from the supplier with consequently smaller capacities. The Osterberg Cell<sup>®</sup> is manufactured in a variety of sizes for both drilled shaft installations and driven pile installations as shown in Tables 9-12 and 9-13, respectively.

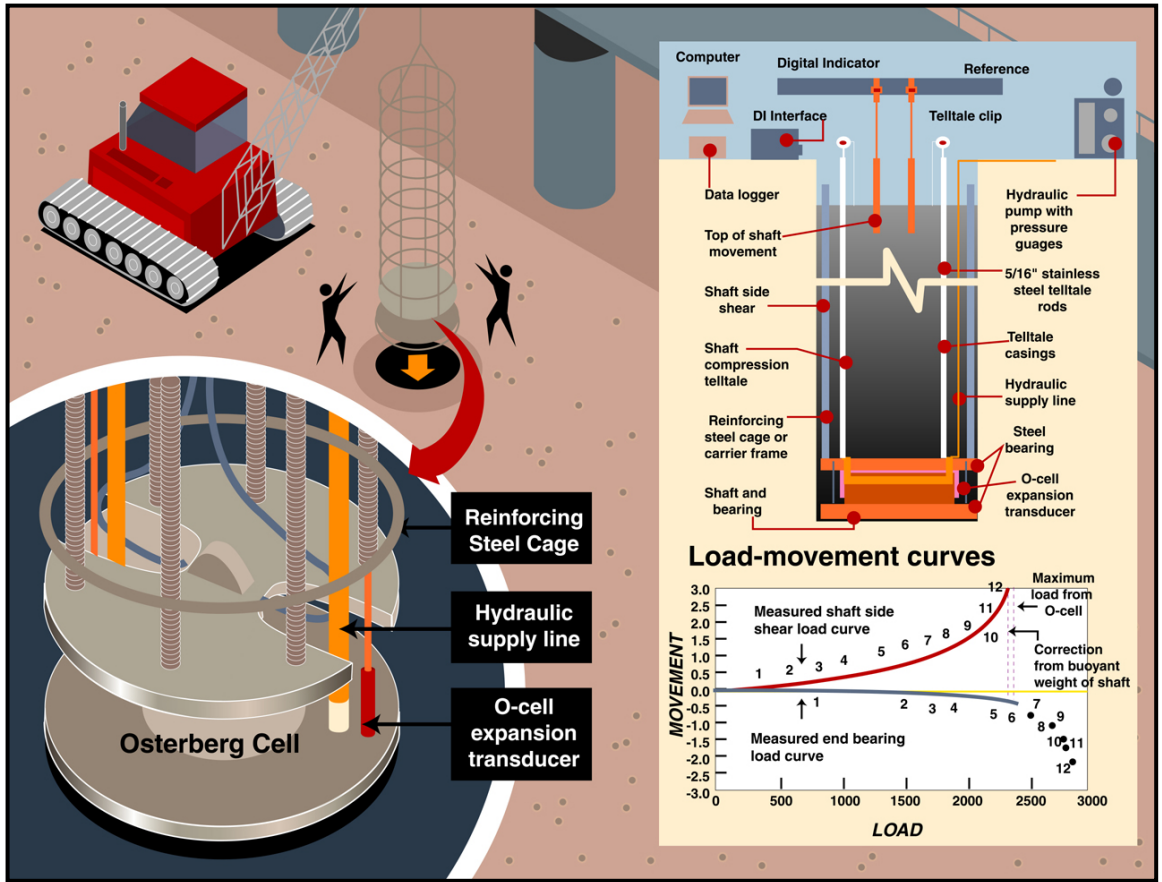
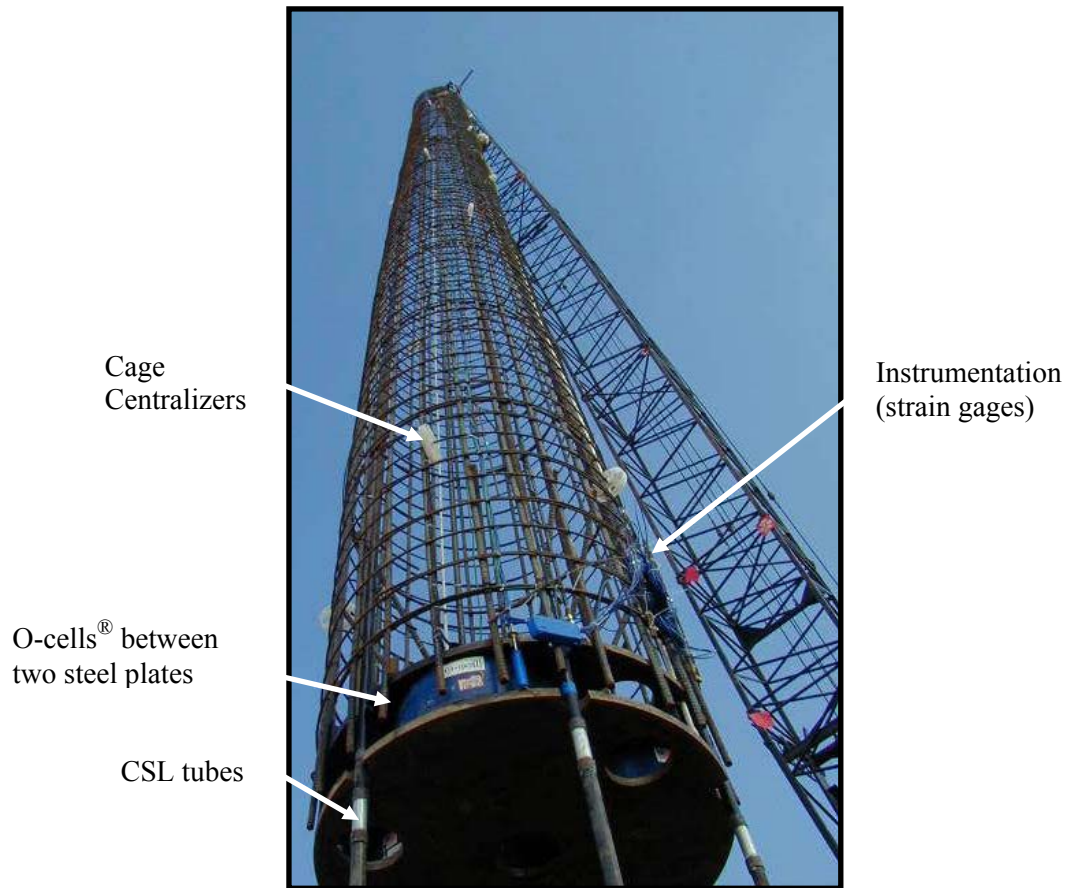

Figure 9-73. Some details of the O-Cell<sup>®</sup> test (after [www.bridgebuildermagazine.com](http://www.bridgebuildermagazine.com)).



Figure 9-74. Photograph of an O-Cell<sup>®</sup>.





**Figure 9-75. O-Cell<sup>®</sup> assembly attached to a reinforcing cage with other instrumentation.**

**Table 9-12. Osterberg Cells<sup>®</sup> for drilled shafts**

Size	Diameter Inches	Height Inches	Capacity Tons	Weight Pounds
5	5.25	5.18	75	32
9	9.00	10.75	200	190
13	13.00	11.65	400	300
21	21.25	11.65	1,200	800
26	26.25	11.65	1,800	1,230
34	34.25	12.37	3,000	2,015

Note: 1 in = 25.4 mm; 1 ton = 8.9 kN

**Table 9-13. Osterberg Cells<sup>®</sup> for driven piles**

Size – Inches	Capacity – Tons	Stroke - Inches	Description of Pile
14	200	6	Round-steel pipe
14	300	6	Square-precast Concrete
18	900	8	Round-steel pipe
30	950	9	Square-precast Concrete

Note: 1 in = 25.4 mm; 1 ton = 8.9 kN

The load being applied to the drilled shaft is usually monitored by measuring the pressure in the fluid being applied by the pump. The Osterberg Cell<sup>®</sup> will therefore need to be calibrated in a testing machine prior to installation to obtain a relationship between the measured pressure and the load applied by the cell. Ordinarily, a calibration is provided by the supplier. Note that in practice the hydraulic pressure will usually be measured at the ground surface, but the cell is situated at some distance below the ground surface, e.g., about 110 ft (33.5 m) for the Osterberg Cell<sup>®</sup> assembly shown in Figure 9-75. Therefore, the actual pressure at the level of the cell is the pressure that is measured plus the vertical distance from the pressure gauge to the middle of the cell times the unit weight of the cell fluid. This correction needs to be made before load versus movement is plotted. Movement can be measured at the top of the cell through telltales attached to the top of the cell that are monitored by movement sensors, e. g., dial gauges suspended from stable reference beams on the ground surface. Similarly, movement can be measured at the top of the test shaft by means of movement sensors suspended from stable reference beams. Movement of the bottom plate can be determined by measuring the movement of the top of the Osterberg Cell<sup>®</sup> with telltales and then measuring the relative movement between the upper and lower ends of the cell by means of sacrificial electronic movement sensors attached between the top and bottom plates.

The O-Cell<sup>®</sup> test has some limitations in that the total failure load of the foundation element cannot usually be measured; only the failure load of the friction above the cell or the resistance below the cell are measured.

The Osterberg Cell<sup>®</sup> has been used in a variety of soil and rock conditions. The cell has been used to determine the bond stress in rock sockets and in dense glacial tills. In addition, a variety of strain gage devices have been used in conjunction with the O-Cell<sup>®</sup> test to develop a distribution of resistance along the foundation element. Such measurements can also be obtained below an Osterberg Cell<sup>®</sup> installed at the mid-height of a shaft by extending instrumented rebar below the base of the cell.

The cost of a single O-cell<sup>®</sup> test, including the Osterberg Cell<sup>®</sup> itself, instrumentation and shaft construction, is often in the range of 50 to 60 per cent of the cost of performing a conventional static load test for situations, such as shafts of small capacity, in which conventional static load tests can be used, although the percentage varies considerably from site to site.

By using multiple Osterberg Cells<sup>®</sup> in a given shaft, it is possible to mobilize up to 25,000 tons of combined side and base resistance. The O-Cell<sup>®</sup> test has not been standardized by

AASHTO or ASTM as of 2006. Additional information on the O-Cell<sup>®</sup> test can be found at [www.loadtest.com](http://www.loadtest.com).

#### **9.15.8.2 The Statnamic<sup>®</sup> Test Method**

The Statnamic<sup>®</sup> test method is a proprietary method developed by the Berminghammer Foundation Corporation ([www.berminghammer.com](http://www.berminghammer.com)). A new ASTM draft standard, entitled “Standard Test Method for Piles under Rapid Axial Compressive Load,” has been proposed but had not been approved as of 2006.

A Statnamic<sup>®</sup> loading test also can be performed without the need for an expensive reaction system. An advantage of this type of test relative to the O-Cell<sup>®</sup> test is that it does not require the loading device to be cast into the shaft. Therefore, the Statnamic<sup>®</sup> loading test can be performed on a drilled shaft for which a loading test was not originally planned.

The principle of the Statnamic<sup>®</sup> test is shown in Figure 9-76. Dead weights are placed upon the surface of the test shaft. Beneath the dead weights is a small volume of propellant and a load cell. The propellant is ignited and accelerates the masses upward. As this occurs a reaction force equal to the masses times their acceleration is produced against the head of the shaft, as indicated in Figure 9-76. This force, which increases with time up to one to two hundred milliseconds, causes the shaft to displace downward. As the ignition of the propellant stops, the reaction force rapidly decreases and the shaft rebounds. The displacement of the shaft head is measured by means of a laser beam from a source located some distance away from the test shaft. The laser beam is targeted on the shaft head. The load can be graphed against both time and displacement instantaneously.

For reasons of safety the reaction masses are contained within a metal sheath that is also filled with an energy absorbing material, such as dry gravel, that will cushion the impact of the masses as they fall back upon the head of the drilled shaft. A photograph of a Statnamic<sup>®</sup> test arrangement, with the gravel-filled sheath surrounding the reaction masses is shown in Figure 9-77 just after igniting the propellant.

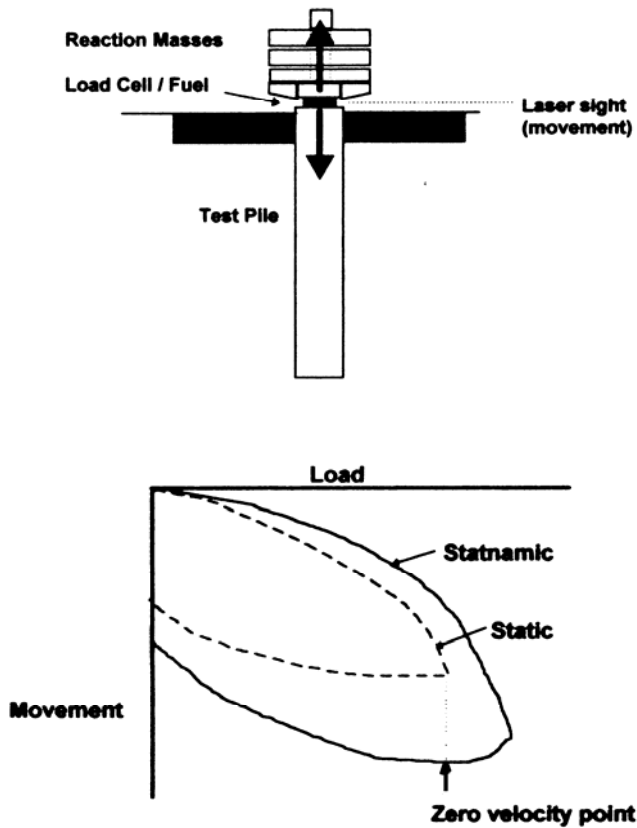

Figure 9-76. Schematic of Statnamic<sup>®</sup> test



Figure 9-77. Photograph of Statnamic<sup>®</sup> test arrangement showing masses being accelerated inside gravel-filled sheath.

Since there are dynamic components to the resistance of the drilled shaft, some interpretation of the data is necessary, as illustrated in the bottom part of Figure 9-76. Since the load produced at the head of the shaft by igniting the propellant is applied much more slowly than the load applied by the blow of a pile-driving hammer, it can usually be assumed that the length of the stress wave that is imparted to the drilled shaft is much longer than the length of the shaft itself and that the shaft is therefore penetrating into the soil or rock as a rigid body. It may not be possible to make this simplifying assumption if the test shaft is extremely long. However, if rigid body motion is assumed, the load acting on the head of the shaft can be reasoned to be the sum of (1) the total static soil resistance (base and sides), (2) damping forces produced by the relative velocity between the shaft and the soil/rock, and (3) the mass of the drilled shaft itself times its acceleration. In the Statnamic<sup>®</sup> test, if the load corresponding to a zero slope on the load-settlement relation measured near the beginning of rebound, as illustrated in Figure 9-76, is selected as the analysis point, then component (2), above, will be zero, since the velocity of the shaft will be zero, and the total static resistance of the drilled shaft,  $R_T$ , can be approximated by :

$$R_T = F_{so} - W_s \left( \frac{a_s}{g} \right) \quad 9-57$$

where,  $F_{so}$  = the force measured by the load cell at the point at which the slope of the rebound curve is zero, identified by the arrow in Figure 9-68

$W_s$  = total weight of the drilled shaft

$a_s$  = acceleration of the drilled shaft corresponding to  $F_{so}$ , which can be measured with an accelerometer at the head of the shaft

$g$  = acceleration of gravity.

Note that  $a_s$  will not be zero despite the fact that the velocity of the test shaft is momentarily zero at  $F_{so}$ . If the test shaft is long, a stress wave analysis may be necessary to obtain an accurate estimate of resistance.

Statnamic<sup>®</sup> devices have been constructed that are capable of applying head loads of up to approximately 3600 tons (32 MN). The cost of a Statnamic<sup>®</sup> test will usually be approximately the same as the cost of an O-Cell<sup>®</sup> test of the same magnitude.

Further technical information on the Statnamic<sup>®</sup> test method can be found in the *Proceedings of the First International Statnamic Seminar*, Vancouver, British Columbia, 1995. Copies

can be obtained from Berminghammer Foundation Equipment Company, Wellington Street Marine Terminal, Hamilton, Ontario L8L 4Z9, Canada. The reader is also referred to FHWA (2006a) for further information on the load test interpretation.

### **9.15.9 Limitations of Compression Load Tests**

Compression load tests can provide a wealth of information for design and construction of pile foundations and are the most accurate method of determining pile capacity. However, static load test results cannot be used to account for long-term settlement, downdrag from consolidating and settling soils, or to represent pile group action adequately. Other shortcomings of static load tests include cost, the time required to setup and complete a test, and the minimal information obtained on driving stresses or extent of potential pile damage. Static load test results can also be misleading on projects with highly variable soil conditions.

### **9.15.10 Axial Tension and Lateral Load Tests**

Load tests can also be performed such that uplift and lateral loading conditions are simulated. Such load tests are described in FHWA (1999) and FHWA (2006a).